

CONTENTS

I. Product	1
1.1 Product model naming rule.....	1
1.2 Optional function naming rule.....	1
1.3 Nameplate.....	2
1.4 Appearance.....	2
1.5 Technical Specifications	4
1.6 Designed Standards for Implementation.....	5
1.7 Safe Instructions.....	5
1.8 Precautions.....	6
1.9 Examination and Maintenance.....	7
II. Keypad panel.....	8
2.1 Panel Illustrations.....	8
2.2 Panel Structure.....	9
2.3 Panel Operating	9
2.4 Parameters Setting	10
2.5 Function Codes Switchover In/Between Code-Groups.....	10
2.6 Panel Display	11
III. Installation & Connection	12
3.1 Installation.....	12
3.2 Connection	12
3.3 Function of Control Terminals.....	14
3.4 Wiring Recommended.....	17
3.5 Lead Section Area of Protect Conductor(grounding wire)	17
3.6 Overall Connection.....	18
IV. Operation and Simple Running	19
V. Function Parameters	26
5.1 Basic Parameters.....	26
5.2 Operation Control	34

5.3	Multifunctional Input and Output Terminals.....	41
5.4	Analog Input and Output.....	45
5.5	Pulse input and output.....	50
5.6	Multi-stage Speed Control.....	52
5.7	Auxiliary Functions.....	54
5.8	Malfunction and Protection.....	56
5.9	Parameters of the motor.....	58
5.10	Communication parameters.....	58
5.11	PID parameters.....	59
Appendix 1	Trouble Shooting.....	60
Appendix 2	Products and Structure List.....	61
Appendix 3	Selection of Braking Resistance	65
Appendix 4	Communication Manual.....	66
Appendix 5	Zoom Table of Function Code	75

I. Product

This manual offers a brief introduction of the installation connection for E1000 series inverters, parameters setting and operations, and should therefore be properly kept. Please contact manufacturer or dealer in case of any malfunction during application.

1.1 Product model naming rule

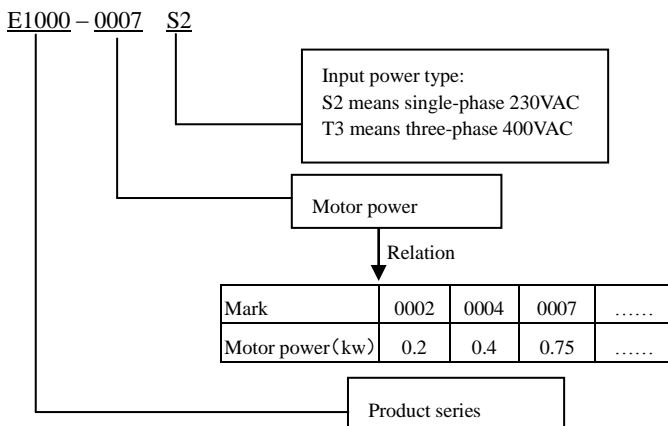

1.2 Optional function naming rule

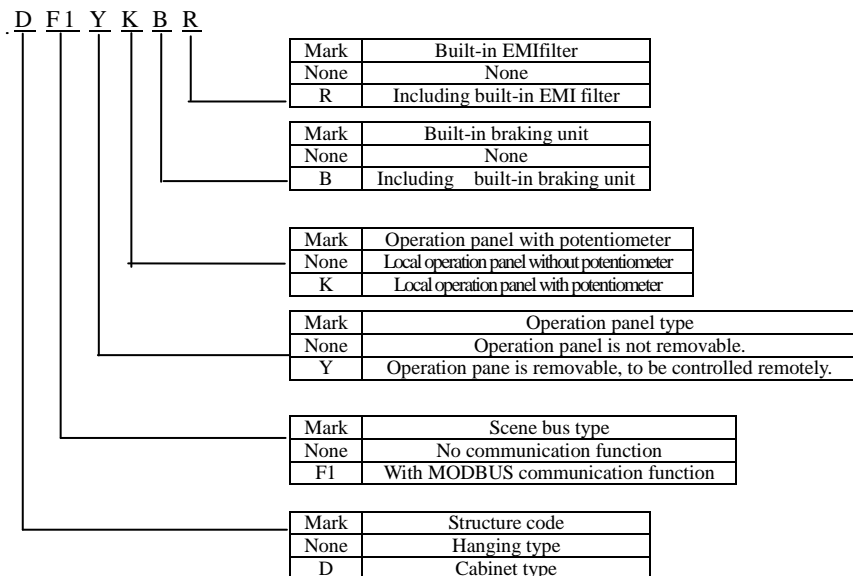

1.3 Nameplate

Taking for instance the E1000 series 0.75KW inverter with 1-phase input, its nameplate is illustrated as Fig 1-1.

1Ph: single-phase input; 230V, 50/60Hz: input voltage range and rated frequency.
 3Ph: 3-phase output; 4.5A, 0.75KW: rated output current and power;
 0.50~650.0Hz: output frequency range.

 EURA DRIVES ELECTRIC CO., LTD			
MODEL	E1000-0007S2	Function Symbol	F1KBR
INPUT	AC 1PH 230V 50/60Hz		
OUTPUT	3PH 0.75KW 4.5A 0~230V		
	0.50~650.0Hz		

Fig 1-1 Nameplate

1.4 Appearance

The external structure of E1000 series inverter is classified into plastic and metal housings. And wall hanging type is adopted. Good poly-carbon materials are adopted through die-stamping for plastic housing with nice form, good strength and toughness. Taking E1000-0007S2 for instance, the external appearance and structure are shown as in below Fig.

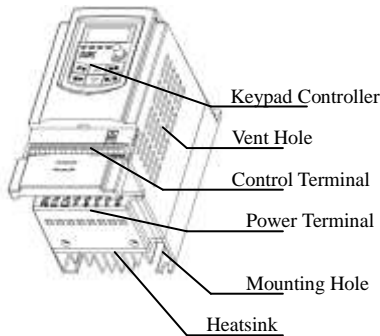

Metal housing uses advanced exterior plastic- spraying and powder-spraying process on the surface with elegant colour and with detachable one-side door hinge structure adopted for front cover, convenient for wiring and maintenance. Taking E1000-0185T3R for instance, its appearance and structure are shown as in right Fig.



1.5 Technical Specifications

Table1-1 **Technical Specifications for E1000 Series Inverters**

	Items	Contents
Input	Rated Voltage Range	3-phase 400V \pm 5%; single-phase 230V \pm 15%
	Rated Frequency	50/60Hz
Output	Rated Voltage Range	3-phase 0~400V;3-phase 0~230V
	Frequency Range	0.50~650.0Hz
Control Mode	Carrier Frequency	2000~10000Hz; Fixed carrier-wave and random carrier-wave can be selected by F159.
	Input Frequency Resolution	Digital setting: 0.01Hz, analog setting: max frequency \times 0.1%
	Control Mode	VVVF control
	Overload Capacity	150% rated current, 60 seconds.
	Torque Elevating	Auto torque promotion, Manual Torque Promotion 0.1%~30.0% (VVVF)
	V/F Curve	3 kinds of modes: beeline type, square type and under-defined V/F curve.
	DC Braking	DC braking frequency: 1.0~5.0 Hz, braking time: 0.0~10.0s
	Jogging Control	Jogging frequency range: min frequency~ max frequency, jogging acceleration/deceleration time: 0.1~3000.0s
Operation Function	Auto Circulating Running and multi-stage speed running	Auto circulating running or terminals control can realize 15-stage speed running.
	Built-in PID adjusting	Easy to realize a system for process closed-loop control
	Frequency Setting	Potentiometer or external analog signal (0~5V, 0~10V, 0~20mA); keypad (terminal) \blacktriangle / \blacktriangledown keys, external control logic and automatic circulation setting.
	Start/Stop Control	Terminal control, keypad control or communication control.
	Running Command Channels	3 kinds of channels from keypad panel, control terminal and series communication port.
Optional	Frequency Source	Frequency sources: given digit, given analog voltage, given analog current and given series communication port.
	Accessory frequency Source	Flexible implementation of 5 kinds of accessory frequency fine adjustments and frequency compound.
Protection Function	Built-in EMI filter, built-in braking unit, Modbus communication, telecontrol panel	
Display	Input out-phase, Output out-phase, input under-voltage, DC over-voltage, over-current, over-load, current stall, over-heat, external disturbance	
	LED nixie tube showing present output frequency, present rotate-speed (rpm), present output current, present output voltage, present linear-velocity, types of faults, and parameters for the system and operation; LED indicators showing the current working status of inverter.	
Environment Conditions	Equipment Location	In an indoor location, Prevent exposure from direct sunlight, Free from dust, tangy caustic gases, flammable gases, steam or the salt-contented, etc.
	Environment Temperature	-10 $^{\circ}$ C~+50 $^{\circ}$ C
	Environment Humidity	Below 90% (no water-bead coagulation)
	Vibration Strength	Below 0.5g (acceleration)
	Height above sea level	1000m or below

Protection level	IP20
Applicable Motor	0.2~630KW

1.6 Designed Standards for Implementation

- IEC/EN 61800-5-1: 2003 Adjustable speed electrical power drive systems safety requirements.
- IEC/EN 61800-3: 2004 Adjustable speed electrical power drive systems-Part 3: EMC product standard including specific test methods.

1.7 Safe instructions

- Please check the model in the nameplate of the inverter and the rated value of the inverter. Please do not use the damaged inverter in transit.
- Installation and application environment should be free of rain, drips, steam, dust and oily dirt; without corrosive or flammable gases or liquids, metal particles or metal powder. Environment temperature within the scope of $-10^{\circ}\text{C}\sim+50^{\circ}\text{C}$.
- Please install inverter away from combustibles.
- Do not drop anything into the inverter.
- The reliability of inverters relies heavily on the temperature. The around temperature increases by 10°C , inverter life will be halved. Because of the wrong installation or fixing, the temperature of inverter will increase and inverter will be damaged.
- If inverter is installed in a control cabinet, smooth ventilation should be ensured

Installing vertically

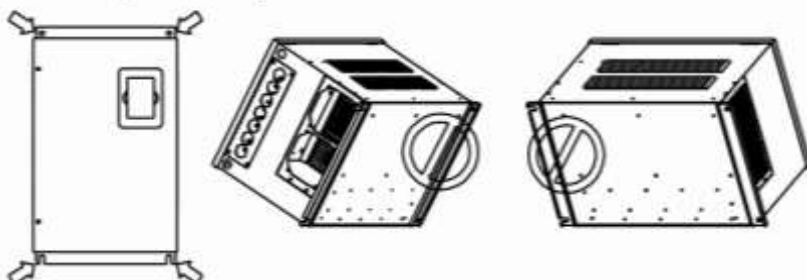

and inverter should be installed vertically. If there are several inverters in one cabinet, in order to ensure ventilation, please install inverters side by side. If it is necessary to install several inverters up and down, please add heat-insulation plate.

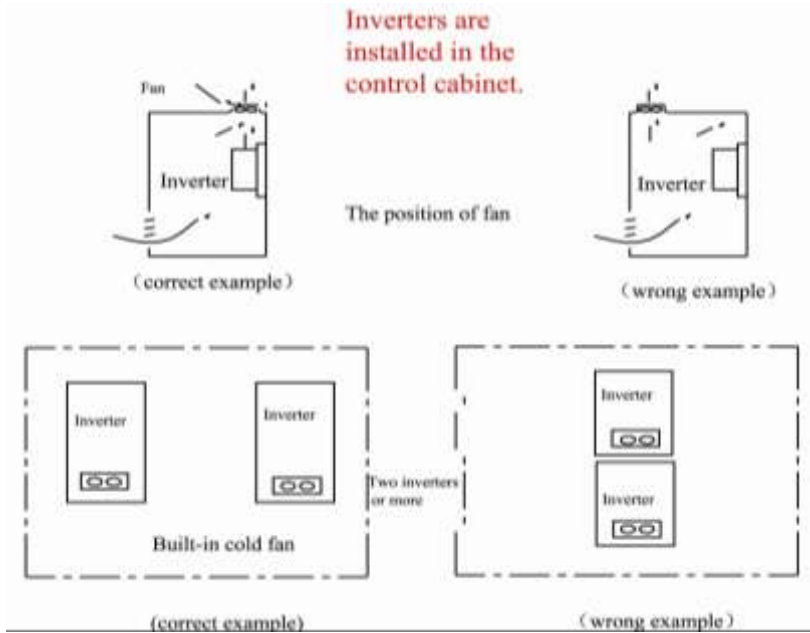

1.8 Precautions

1.8.1 Instructions for use

- Never touch the internal elements within 15 minutes after power off. Wait till it is completely discharged.
- Input terminals R, S and T are connected to power supply of 400V while output terminals U, V and W are connected to motor.
- Proper grounding should be ensured with grounding resistance not exceeding 4Ω; separate grounding is required for motor and inverter. Grounding with series connection is forbidden.
- Load switch is forbidden at output while inverter is in operation.
- AC reactor or/and DC reactor is recommended when your inverter is above 37KW.
- There should be separate wiring between control loop and power loop to avoid any possible interference.
- Signal line should not be too long to avoid any increase with common mode interference.
- It shall comply with the requirements for surrounding environment as stipulated in Table 1-1 “**Technical Specifications for E1000 Series Inverter**”.

1.8.2 Special Warning

- Never touch high-voltage terminals inside the inverter to avoid any electric shock.
- Before inverter is powered on, please be sure that input voltage is correct.
- Please do not connect input power supply onto U,V,W or \hbar terminals.
- Please do not install inverter directly under sunshine, do not block up the cooling hole.

- All safety covers should be well fixed before inverter is power connected, to avoid any electric shock.
- Only professional personnel are allowed for any maintenance, checking or replacement of parts.
- No live-line work is allowed.

1.9 Maintenance

1.9.1 Periodic Checking

- Cooling fan and wind channel should be cleaned regularly to check whether it is normal; remove the dust accumulated in the inverter on a regular basis.
- Check inverter's input and output wiring and wiring terminals regularly and check if wirings are ageing.
- Check whether screws on each terminals are fastened.
- Check whether inverter is corrosive.

1.9.2 Replacement of wearing parts

The wearing parts include cooling fan and electrolytic capacitors.

- The life of the fan usually is 2~3 years. Users should change the cooling fan according to all running time of inverter. Cooling fan could be damaged because bearing is damaged and fan blades are aging. Users could check fan blades for cracks or check the abnormal vibration noise when starting. Users could change fan according to abnormal phenomena.
- The useful life of electrolytic capacitors is 4~5 years. Users should change the electrolytic capacitors according to all running time of inverter. Capacitors could be damaged because the power supply is unstable, the environment temperature is high, frequent over-load occurs and electrolyte is ageing. By checking whether there is leakage of liquid, or the safety valve bulges out, or the static electricity and insulated resistor is ok, users could change the capacitor according to these phenomena.

1.9.3 Storage

- Please put the inverter in the packing case of manufacture.
- If inverter is stored for long time, please charge the inverter within half a year to prevent the electrolytic capacitors damaged. The charging time should be longer than 5 hours.

1.9.4 Daily Maintenance

Environment temperature, humidity, dust and vibration would decrease the life of inverter. So daily maintenance is necessary to inverter.

Daily inspecting:

- Inspecting for noise of motor when it is working.
- Inspecting for abnormal vibration of motor when it is working.
- Inspecting for the installing environment of inverter.
- Inspecting for the fan and inverter temperature.

Daily cleaning:

● Keep the inverter clean. Clean surface dust of inverter to prevent dust, metal powder, oily dirt and water from dropping into the inverter. Inspecting for the fan and inverter temperature.

Daily cleaning:

Keep the inverter clean. Clean surface dust of inverter to prevent dust, metal powder, oily dirt and water from dropping into the inverter.

II. Keypad panel

Keypad panel and monitor screen are both fixed on keypad controller. Two kinds of controllers (with and without potentiometer) are available for E1000 series inverters. Refer to note for Fig2-1.

2.1 Panel Illustration

The panel covers three sections: data display section, status indicating section and keypad operating section, as shown in Fig. 2-1.

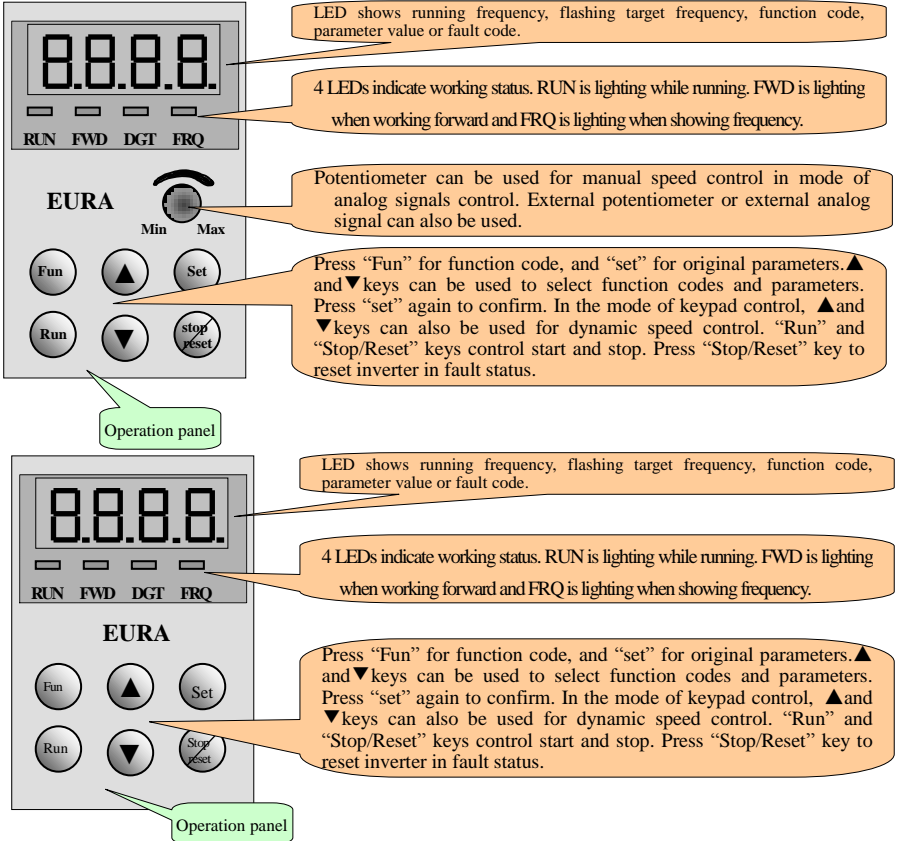

Fig.2-1 Operation Panels in Two Kinds

Instructions for operation panel:

1. Operation panels of below 15KW can not be pulled out. Please select AA or A6 control panel to realize remote control, which is connected by 4 core telephone wire.
2. Operation panels of above 18.5KW can be pulled out, which is connected by 8 core net cable.

2.2 Panel structure

1. structure diagram

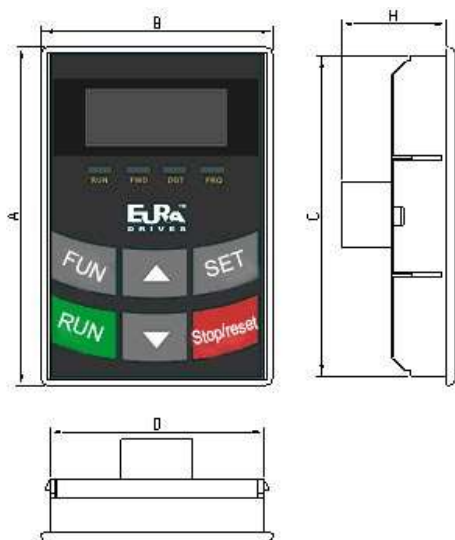

2. Structure size (Unit: mm)

Code	A	B	C	D	H	Opening size
AA	76	52	72	48	24	73*49
A6	124	74	120	70	26	121*71

2.3 Panel Operating

All keys on the panel are available for user. Refer to Table 2-1 for their functions.

Table 2-1















Uses of Keys

Keys	Names	Remarks
	Fun	To call function code and switch over display mode.
	Set	To call and save data.
	Up	To increase data (speed control or setting parameters)
	Down	To decrease data (speed control or setting parameters)
	Run	To start inverter;
	Stop or reset	To stop inverter; to reset in fault status; to change function codes in a code group or between two code groups.

2.4 Parameters Setting

This inverter has numerous function parameters, which the user can modify to effect different modes of operation control. User needs to realize that if user sets password valid (F107=1), user's password must be entered first if parameters are to be set after power off or protection is effected, i.e., to call F100 as per the mode in Table 2-2 and enter the correct code. User's password is invalid before delivery, and user could set corresponding parameters without entering password.

Table 2-2 Steps for Parameters Setting

Steps	Keys	Operation	Display
1		Press "Fun" key to display function code	
2	 or 	Press "Up" or "Down" to select required function code	
3		To read data set in the function code	
4	 or 	To modify data	
5		To show corresponding target frequency by flashing after saving the set data	
		To display the current function code	

The above-mentioned step should be operated when inverter is in stop status.

2.5 Function Codes Switchover in/between Code-Groups

It has more than 300 parameters (function codes) available to user, divided into 10 sections as indicated in Table 2-3.

Table 2-3 Function Code Partition

Group Name	Function Code Range	Group No.	Group Name	Function Code Range	Group No.
Basic Parameters	F100~F160	1	Subsidiary function	F600~F630	6
Run Control Mode	F200~F230	2	Timing control and protection function	F700~F740	7
Multi-functional input/output terminal	F300~F330	3	Parameters of the motor	F800~F830	8
Analog signals of input/output	F400~F439	4	Communication function	F900~F930	9
Pulse of input/output	F440~F460	4	PID parameter setting	FA00~FA30	10
Multi-stage speed parameters	F500~F580	5			

As parameters setting costs time due to numerous function codes, such function is specially designed as "Function Code Switchover in a Code Group or between Two Code-Groups" so that parameters setting become convenient and simple.

Press "Fun" key so that the keypad controller will display function code. If press "▲" or "▼" key then,

function code will circularly keep increasing or decreasing by degrees within the group; if press the “stop/reset” key again, function code will change circularly between two code groups when operating the “▲” or “▼” key.

e.g. when function code shows F111 and DGT indicator is on, press “▲”/“▼” key, function code will keep increasing or decreasing by degrees within F100~F160; press “stop/reset” key again, DGT indicator will be off. When pressing “▲”/“▼” key, function codes will change circularly among the 10 code-groups, like F211, F311...FA11, F111..., Refer to Fig 2-2 (The sparkling “50.00” is indicated the corresponding target frequency values).

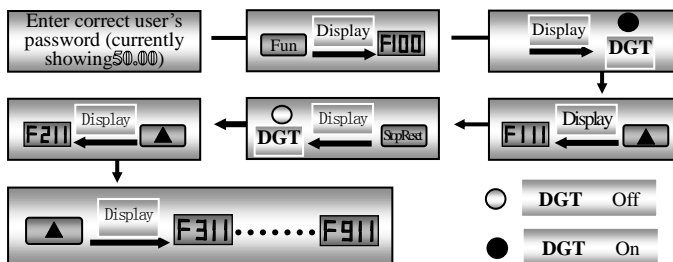

Fig 2-2 Switch over in a Code Group or between Different Code-Groups

2.6 Panel Display

Table 2-4 Items and Remarks Displayed on the Panel

Items	Remarks
HF-0	This Item will be displayed when you press “Fun” in stopping status, which indicates jogging operation is valid. But HF-0 will be displayed only after you change the value of F132.
-HF-	It stands for resetting process and will display target frequency after reset.
OC, OC1, OE, OL1, OL2, OH, LU, PR0, PF1	Fault code, indicating “hardware over-current”, “software over-current”, “over-voltage”, “inverter over-load”, “motor over-load”, “over-heat”, “under-voltage for input”, “out-phase for input”, and “out-phase for output” respectively.
ESP	During two-line/three line running mode, “stop/reset” key is pressed or external emergency stop terminal is closed, ESP will be displayed.
F152	Function code (parameter code).
10.00	Indicating inverter’s current running frequency (or rotate speed) and parameter setting values, etc.
50.00	Sparkling in stopping status to display target frequency.
0.	Holding time when changing the running direction. When “Stop” or “Free Stop” command is executed, the holding time can be canceled
A100, U100	Output current (100A) and output voltage (100V). Keep one digit of decimal when current is below 100A.

III. Installation & Connection

3.1 Installation

Inverter should be installed vertically, as shown in Fig 3-1. Sufficient ventilation space should be ensured in its surrounding. Clearance dimensions (recommended) are available from Table 3-1 for installing the inverter.

Table 3-1 Clearance Dimensions

Inverter Model	Clearance Dimensions	
Hanging (<22kw)	A≥150mm	B≥50mm
Hanging (≥22kw)	A≥200mm	B≥75mm
Cabinet (110~630kw)	C≥200mm	D≥75mm

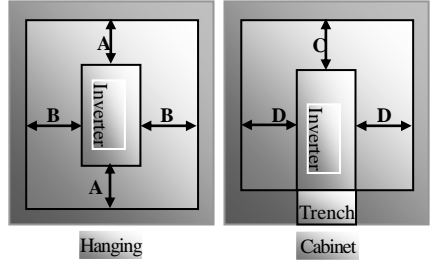
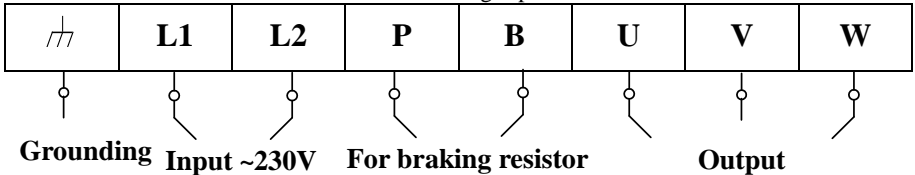

Fig 3-1 Installation Sketch

3.2 Connection

- In case of 3-phase input, connect R/L1, S/L2 and T/L3 terminals (L1/R and L2/S terminals for single-phase) with power source from network and PE/E to earthing, U, V and W terminals to motor.
- Motor shall have to be ground connected. Or else electrified motor causes interference.
- For inverter power lower than 15kw, braking cell is also built-in. If the load inertia is moderate, it is Ok to only connect braking resistance.

Power terminals sketch of inverter with single-phase 230V 0.2~0.75KW.



Power terminals sketch of inverter with single-phase 230V 1.5~2.2KW and three-phase 400V 0.75KW~15KW.

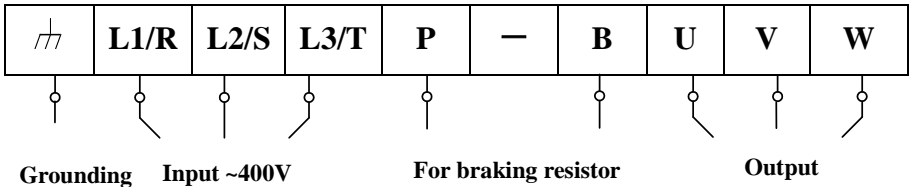

Note: power terminals L1/R, L2/S of single-phase 230V 1.5KW and 2.2KW are connected to 230V of power grid; L3/T is not connected.

The inverters below 11kw have no the terminal “—”.

Power terminals sketch of inverter with three-phase 400V above 18.5KW

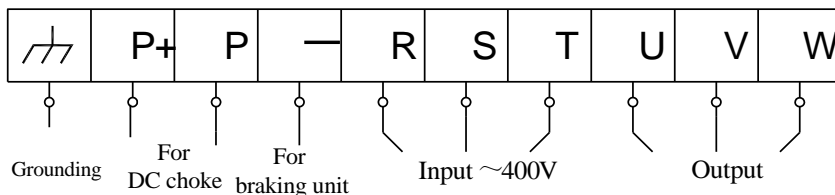

(The figure is only sketch, terminals order of practical products may be different from the above-mentioned figure.)

Introduction of terminals of power loop

Terminals	Terminal Marking	Terminal Function Description
Power Input Terminal	R/L1, S/L2, T/L3	Input terminals of three-phase 400V AC voltage (R/L1 and S/L2 terminals for single-phase)
Output Terminal	U, V, W	Inverter power output terminal, connected to motor.
Grounding Terminal	⏏/PE/E	Inverter grounding terminal.
Rest Terminal	P, B	External braking resistor (Note: no Terminals P or B for inverter without built-in braking unit).
	P+, -(N)	DC bus-line output
	P, -(N)	Externally connected to braking unit P connected to input terminal "P" or "DC+" of braking unit, -(N) connected to input terminal of braking unit "N" or "DC-".
	P, P+	Externally connected to DC reactor

Wiring for control loop as follows:

A+	B-	TA	TB	TC	DO1	DO2	24V	CM	OP1	OP2	OP3	OP4	OP5	OP6	OP7	OP8	10V	AI1	AI2	GND	AO1	AO2
----	----	----	----	----	-----	-----	-----	----	-----	-----	-----	-----	-----	-----	-----	-----	-----	-----	-----	-----	-----	-----

Note: 15KW inverters and below 15KW have no A+, B-, DO2 and OP7, OP8 control terminal.

3.3 Functions of control terminals

The key to operate the inverter is to operate the control terminals correctly and flexibly. Certainly, the control terminals are not operated separately, and they should match corresponding settings of parameters. This chapter describes basic functions of the control terminals. The users may operate the control terminals by combining relevant contents hereafter about “Defined Functions of the Terminals”.

Table 4-3 **Functions of Control Terminals**

Terminal	Type	Description	Function	
DO1	Output signal	Multifunctional output terminal 1	When the token function is valid, the value between this terminal and CM is 0V; when the inverter is stopped, the value is 24V.	The functions of output terminals shall be defined per manufacturer's value. Their initial state may be changed through changing function codes.
DO2 ^{Note}		Multifunctional output terminal 2	When the token function is valid, the value between this terminal and CM is 0V; when the inverter is stopped, the value is 24V.	
TA		Relay contact	TC is a common point, TB-TC are normally closed contacts, TA-TC are normally open contacts. The contact capacity of 15kw and below 15kw inverter is 10A/125VAC, 5A/250VAC, 5A/30VDC, contact capacity of above 15kw is 12A/125VAC, 7A/250VAC, 7A/30VDC.	
TB				
TC				
AO1		Running frequency	It is connected with frequency meter or speedometer externally, and its minus pole is connected with GND. See F423~F426 for details..	
AO2	Current display	It is connected with ammeter externally, and its minus pole is connected with GND. See F427~F430 for details		
10V	Analog power supply	Self contained power supply	Internal 10V self-contained power supply of the inverter provides power to the inverter. When used externally, it can only be used as the power supply for voltage control signal, with current restricted below 20mA.	
AI1	Input Signal	Voltage analog input port	When analog speed control is adopted, the voltage signal is input through this terminal. The range of voltage input is 0~10V, grounding: GND. When potentiometer speed control is adopted, this terminal is connected with center tap, earth wire to be connected to GND.	
AI2		Voltage / Current analog input port	When analog speed control is adopted, the voltage or current signal is input through this terminal. The range of voltage input is 0~5V or 0~10V and the current input is 0~20mA, input resistor is 500Ω, grounding: GND. If the input is 4~20mA, it can be realized through adjusting parameter F406=2. The voltage or current signal can be chosen by coding switch. See table 4-2 and 4-3 for details, the current channel (0-20mA) is chosen before delivery.	
GND		Self-contained Power supply Ground	Ground terminal of external control signal (voltage control signal or current source control signal) is also the ground of 10V power supply of this inverter.	
24V	Power supply	Control power supply	Power: 24±1.5V, grounding: CM; current is restricted below 50mA for external use.	
OP1	Digital input control terminal	Jogging terminal	When this terminal is in the valid state, the inverter will have jogging running. The jogging function of this terminal is valid under both at stopped and running status. This terminal can also be used as high-speed pulse input port. The max frequency is 50K.	The functions of input terminals shall be defined per manufacturer's value. Other functions can also be defined by changing function codes.
OP2		External Emergency Stop	When this terminal is in the valid state, “ESP” malfunction signal will be displayed.	

OP3		“FWD” Terminal	When this terminal is in the valid state, inverter will run forward.
OP4		“REV” Terminal	When this terminal is in the valid state, inverter will run reversely.
OP5		Reset terminal	Make this terminal valid under fault status to reset the inverter.
OP6		Free-stop	Make this terminal valid during running can realize free stop.
OP7		Running terminal	When this terminal is in the valid state, inverter will run by the acceleration time.
OP8		Stop terminal	Make this terminal valid during running can realize stop by the deceleration time.
CM		Common port	Grounding of control power supply
A+ ^{note}	485 communication terminals	Positive polarity of differential signal	Standard: TIA/EIA-485(RS-485) Communication protocol: Modbus Communication rate: 1200/2400/4800/9600/19200/38400/57600bps
B- ^{note}		Negative polarity of Differential signal	

Note : 15KW inverters and below 15KW have no A+, B-, DO2 and OP7, OP8 control terminal.

Wiring for digital input terminals:

Generally, shield cable is adopted and wiring distance should be as short as possible. When active signal is adopted, it is necessary to take filter measures to prevent power supply interference. Mode of contact control is recommended.

Digital input terminals are only connected by source electrode (NPN mode) or by drain electrode (PNP mode). If NPN mode is adopted, please turn the toggle switch to the end of “NPN”.

Wiring for control terminals as follows:

1. Wiring for positive source electrode (NPN mode).

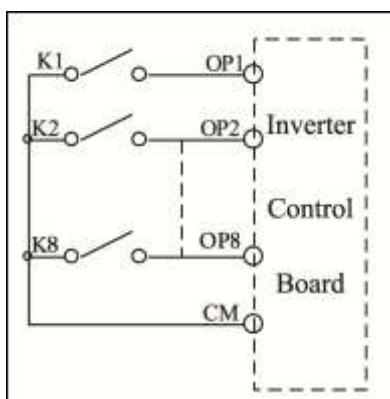

2. Wiring for active source electrode (NPN mode)

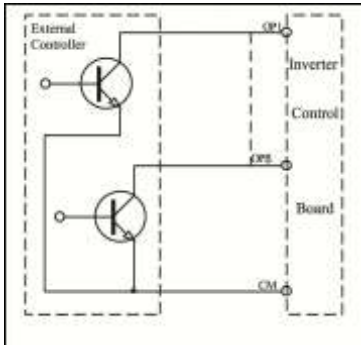

If digital input control terminals are connected by drain electrode, please turn the toggle switch to the end of “PNP”. Wiring for control terminals as follows:

3. Wiring for positive drain electrode (PNP mode)

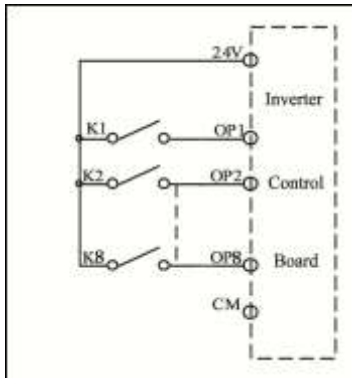

4. Wiring for active drain electrode (PNP mode)

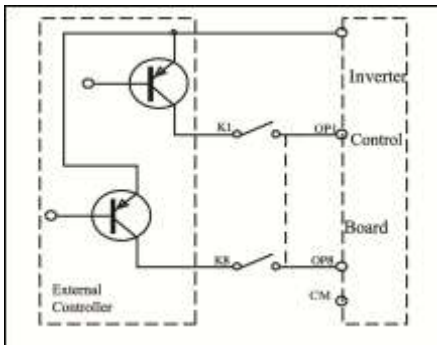

Wiring by source electrode is a mode most in use at present. Wiring for control terminal is connected by source electrode before delivery, user should choose wiring mode according to requirement.

Instructions of choosing NPN mode or PNP mode:

1. There is a toggle switch J7 near to control terminals. Please refer to Fig 3-2.

2. When turning J7 to “NPN”, OP terminal is connected to CM.

When turning J7 to “PNP”, OP terminal is connected to 24V.

3. J7 is on the back of control PCB of single-phase 0.2KW-0.75KW.



Fig 3-2 Toggle Switch J7

3.4 Wiring Recommended

Inverter Model	LeadSectionArea(mm ²)	Inverter Model	LeadSectionArea(mm ²)
E1000-0002S2	1.0	E1000-0550T3	35
E1000-0004S2	1.5	E1000-0750T3	50
E1000-0007S2	2.5	E1000-0900T3	70
E1000-0015S2	2.5	E1000-1100T3	70
E1000-0022S2	4.0	E1000-1320T3	95
E1000-0007T3	1.5	E1000-1600T3	120
E1000-0015T3	2.5	E1000-1800T3	120
E1000-0022T3	2.5	E1000-2000T3	150
E1000-0037T3	2.5	E1000-2200T3	185
E1000-0040T3	2.5	E1000-2500T3	240
E1000-0055T3	4.0	E1000-2800T3	240
E1000-0075T3	4.0	E1000-3150T3	300
E1000-0110T3	6.0	E1000-3550T3	300
E1000-0150T3	10	E1000-4000T3	400
E1000-0185T3	16	E1000-4500T3	480
E1000-0220T3	16	E1000-5000T3	520
E1000-0300T3	25	E1000-5600T3	560
E1000-0370T3	25	E1000-6300T3	720
E1000-0450T3	35		

3.5 Lead section area of protect conductor (grounding wire)

Lead section area S of U,V,W (mm ²)	Minimum lead section area S of PE/E (mm ²)
$S \leq 16$	S
$16 < S \leq 35$	16
$35 < S$	S/2

3.6 Overall Connection and “Three- Line” Connection

* Refer to next figure for overall connection sketch for E1000 series inverters. Wiring mode is available for various terminals whereas not every terminal needs connection when applied.

Note:

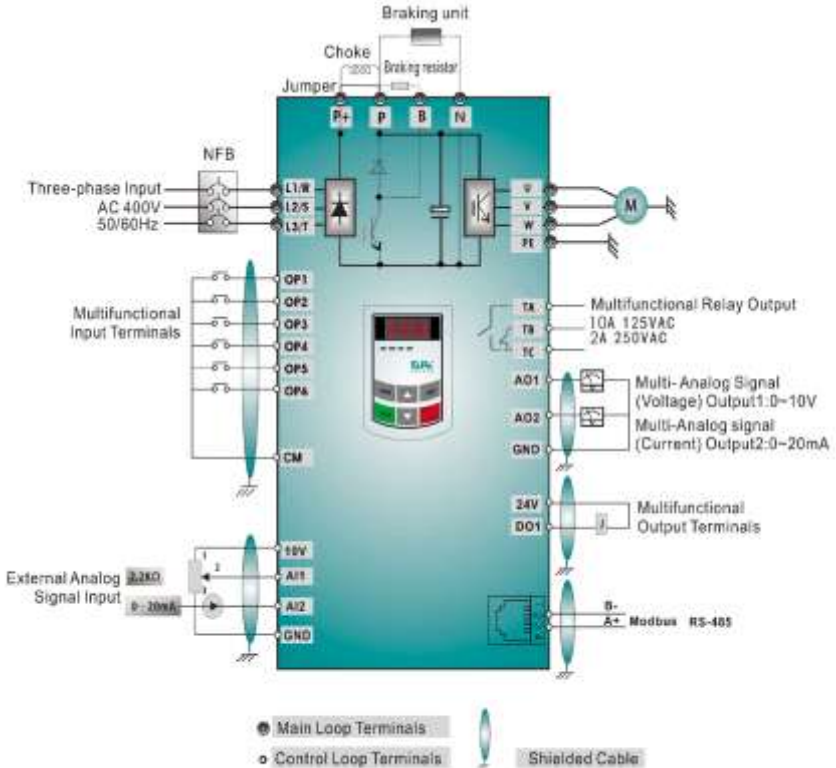

Basic Wiring Diagram for Three-phase AC drives (NPN type)

1. Please only connect power terminals L1/R and L2/S with power grid for single-phase inverters.
2. Remote-control panels and 485 communication port should be connected with 4 core telephone wire. They must not be used at the same time.
3. 485 communication port has built-in standard MODBUS communication protocol. Communication port is on the left side of inverter. The sequence from top to down is 5V power, B-terminal, A+ terminal and GND terminal.
4. Inverter above 15kw has 8 multifunctional input terminals OPI~OP8, 15kw inverter and below 15kw has 6 multifunctional input terminals OPI~OP6.
5. The contact capacity of 15kw and below 15kw inverter is 10A/125VAC, 5A/250VAC, 5A/30VDC, contact capacity of above 15kw is 12A/125VAC, 7A/250VAC, 7A/30VDC.

IV. Operation and Simple Running

This chapter defines and interprets the terms and nouns describing the control, running and status of the inverter. Please read it carefully. It will be helpful to your correct operation.

4.1 Control mode

Control mode of E1000 inverter is V/F control.

4.2 Mode of torque compensation

Linear compensation (F137=0); Square compensation (F137=1); User-defined multipoint compensation (F137=2); Auto torque compensation (F137=3)

4.3 Mode of frequency setting

Please refer to F203~F207 for the method for setting the running frequency of the E1000 inverter.

4.4 Mode of controlling for running command

The channel for inverter to receive control commands (including start, stop and jogging, etc) contains three modes: 1. Keypad (keypad panel) control; 2. External terminal control; 3. Modbus control.

The modes of control command can be selected through the function codes F200 and F201.

4.5 Operating status of inverter

When the inverter is powered on, it may have four kinds of operating status: stopped status, programming status, running status, and fault alarm status. They are described in the following:

4.5.1 Stopped status

If re-energize the inverter (if “self-startup after being powered on” is not set) or decelerate the inverter to stop, the inverter is at the stopping status until receiving control command. At this moment, the running status indicator on the keypad goes off, and the display shows the display status before power down.

4.5.2 Programming status

Through keypad panel, the inverter can be switched to the status that can read or change the function code parameters. Such a status is the programming status.

There are numbers of function parameters in the inverter. By changing these parameters, the user can realize different control modes.

4.5.3 Running status

The inverter at the stopped status or fault-free status will enter running status after having received operation command.

The running indicator on keypad panel lights up under normal running status.

4.5.4 Fault alarm status

The status under which the inverter has a fault and the fault code is displayed.

Fault codes mainly include: OC, OE, OL1, OL2, OH, LU, PF1, representing “over current”, “over voltage”, “inverter overload”, “motor overload”, “overheat”, “input undervoltage”, “input out-phase”, and respectively.

For trouble shooting, please refer to Appendix I to this manual, “Trouble Shooting”.

4.6 Keypad panel and operation method

Keypad panel (keypad) is a standard part for configuration of E1000 inverter. Through keypad panel, the user may carry out parameter setting, status monitoring and operation control over the inverter. Both keypad panel and display screen are arranged on the keypad controller, which mainly consists of three sections: data display section, status indicating section, and keypad operating section. There are two types of keypad controller (with potentiometer or without potentiometer) for inverter. For details, please refer to Chapter II of

this manual, “Keypad panel”.

It is necessary to know the functions and how to use the keypad panel. Please read this manual carefully before operation.

4.6.1 Method of operating the keypad panel

(1) Operation process of setting the parameters through keypad panel

A three-level menu structure is adopted for setting the parameters through keypad panel of inverter, which enables convenient and quick searching and changing of function code parameters.

Three-level menu: Function code group (first-level menu) → Function code (second-level menu) → Set value of each function code (third-level menu).

(2) Setting the parameters

Setting the parameters correctly is a precondition to give full play of inverter performance. The following is the introduction on how to set the parameters through keypad panel.

Operating procedures:

- ① Press the “Fun” key, to enter programming menu.
- ② Press the key “Stop/Reset”, the DGT lamp goes out. Press ▲ and ▼, the function code will change within the function code group. The first number behind F displayed on the panel is 1, in other words, it displays F1××at this moment.
- ③ Press the key “Stop/Reset” again, the DGT lamp lights up, and the function code will change within the code group. Press ▲ and ▼ to change the function code to F113; press the “Set” key to display 50.00; while press ▲ and ▼ to change to the need frequency.
- ④ Press the “Set” key to complete the change.

4.6.2 Switching and displaying of status parameters

Under stopped status or running status, the LED digitron of inverter can display status parameters of the inverter. Actual parameters displayed can be selected and set through function codes F131 and F132. Through the “Fun” key, it can switch over repeatedly and display the parameters of stopped status or running status. The followings are the description of operation method of displaying the parameters under stopped status and running status.

(1) Switching of the parameters displayed under stopped status

Under stopped status, inverter has five parameters of stopped status, which can be switched over repeatedly and displayed with the keys “Fun” and “Stop/Reset”. These parameters are displaying: keypad jogging, target rotary speed, PN voltage, PID feedback value, and temperature. Please refer to the description of function code F132.

(2) Switching of the parameters displayed under running status

Under running status, eight parameters of running status can be switched over repeatedly and displayed with the keys “Fun”. These parameters are displaying : output rotary speed, output current, output voltage, PN voltage, PID feedback value, temperature, count value and linear speed. Please refer to the description of function code F131.

4.7 Operation process of measuring motor stator resistance parameters

The user shall input the parameters accurately as indicated on the nameplate of the motor prior to selecting auto torque compensation (F137=3). Inverter will match standard motor stator resistance parameters according to these parameters indicated on the nameplate. To achieve better control performance, the user may start the inverter to measure the motor stator resistance parameters, so as to obtain accurate parameters of the motor controlled.

The stator resistance parameters of the motor can be measured through function code F800.

For example: If the parameters indicated on the nameplate of the motor controlled are as follows: numbers of motor poles are 4; rated power is 7.5KW; rated voltage is 400V; rated current is 15.4A; rated frequency is 50.00HZ; and rated rotary speed is 1440rpm, operation process of measuring the parameters shall be done as described in the following:

1. In accordance with the above motor parameters, set the values of F801 to F805 correctly: set the value of F801 = 7.5, F802 = 400, F803 = 15.4, F804 = 4, and F805 = 1440 respectively.
2. In order to ensure dynamic control performance of the inverter, set F800=1, i.e. select stator resistance parameter measurement. Press the “Run” key on the keypad, and the inverter will display “TEST”, after few seconds, self-checking is completed, motor stator resistance parameters will be stored in function code F806, and F800 will turn to 0 automatically.

4.8 Operation process of simple running

Table 4-1 Brief Introduction to Inverter Operation Process

Process	Operation	Reference
Installation and operation environment	Install the inverter at a location meeting the technical specifications and requirements of the product. Mainly take into consideration the environment conditions (temperature, humidity, etc) and heat radiation of the inverter, to check whether they can satisfy the requirements.	See Chapters I, II, III.
Wiring of the inverter	Wiring of input and output terminals of the main circuit; wiring of grounding; wiring of switching value control terminal, analog terminal and communication interface, etc.	See Chapter III.
Checking before getting energized	Make sure that the voltage of input power supply is correct; the input power supply loop is connected with a breaker; the inverter has been grounded correctly and reliably; the power cable is connected to the power supply input terminals of inverter correctly (R/L1, S/L2 terminals for single-phase power grid, and R/L1, S/L2, and T/L3 for three-phase power grid); the output terminals U, V, and W of the inverter are connected to the motor correctly; the wiring of control terminals is correct; all the external switches are preset correctly; and the motor is under no load (the mechanical load is disconnected from the motor).	See Chapters I~III
Checking immediately after energized	Check if there is any abnormal sound, fuming or foreign flavor with the inverter. Make sure that the display of keypad panel is normal, without any fault alarm message. In case of any abnormality, switch off the power supply immediately.	See Appendix 1 and Appendix 2.
Inputting the parameters indicated on the motor's nameplate correctly, and measuring the motor stator resistance parameters.	Make sure to input the parameters indicated on the motor nameplate correctly, and measure the motor stator resistance parameters to get the best control performance.	See description of parameter group F800~F830
Setting running control parameters	Set the parameters of the inverter and the motor correctly, which mainly include target frequency, upper and lower frequency limits, acceleration/deceleration time, and direction control command, etc. The user can select corresponding running control mode according to actual applications.	See description of parameter group.
Checking under no load	With the motor under no load, start the inverter with the keypad or control terminal. Check and confirm running status of the drive system. Motor's status: stable running, normal running, correct rotary direction, normal acceleration/deceleration process, free from abnormal vibration, abnormal noise and foreign flavor. Inverter's status: normal display of the data on keypad panel, normal running of the fan, normal acting sequence of the relay, free from the abnormalities like vibration or noise. In case of any abnormality, stop and check the inverter immediately.	See Chapter IV.

Checking under with load	After successful test run under no load, connect the load of drive system properly. Start the inverter with the keypad or control terminal, and increase the load gradually. When the load is increased to 50% and 100%, keep the inverter run for a period respectively, to check if the system is running normally. Carry out overall inspection over the inverter during running, to check if there is any abnormality. In case of any abnormality, stop and check the inverter immediately.	
Checking during running	Check if the motor is running stably, if the rotary direction of the motor is correct, if there is any abnormal vibration or noise when the motor is running, if the acceleration/deceleration process of the motor is stable, if the output status of the inverter and the display of keypad panel is correct, if the blower fan is run normally, and if there is any abnormal vibration or noise. In case of any abnormality, stop the inverter immediately, and check it after switching off the power supply.	

4.9 Illustration of basic operation

Illustration of inverter basic operation: we hereafter show various basic control operation processes by taking a 7.5kW inverter that drives a 7.5kW three-phase asynchronous AC motor as an example.

The parameters indicated on the nameplate of the motor are as follows: 4 poles; rated power, 7.5KW; rated voltage, 400V; rated current, 15.4A; rated frequency 50.00HZ; and rated rotary speed, 1440rpm.

4.9.1 Operation processes of frequency setting, start, forward running and stop with keypad panel

- (1) Connect the wires in accordance with Figure 4-1. After having checked the wiring successfully, switch on the air switch, and power on the inverter.

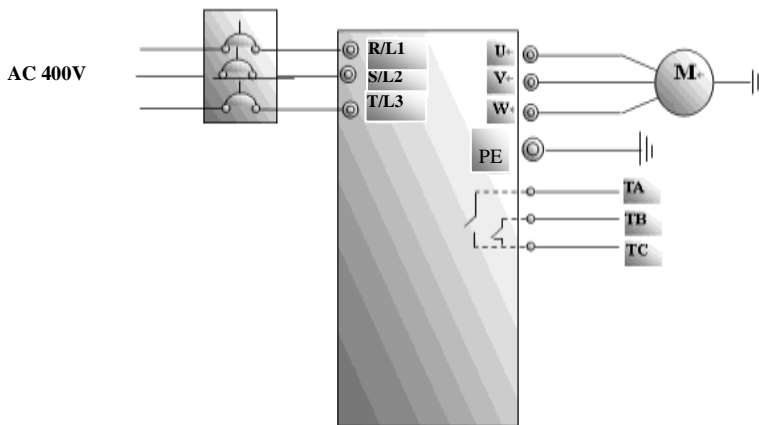

Figure 4-1 Wiring Diagram 1

- (2) Press the “Fun” key, to enter the programming menu.
- (3) Measure the parameters of motor stator resistance parameter
 - ① Enter F801 parameter and set rated power of the motor to 7.5kW;
 - ② Enter F802 parameter and set rated voltage of the motor to 400V;
 - ③ Enter F803 parameter and set rated current of the motor to 15.4A;
 - ④ Enter F804 parameter and set number of poles of the motor to 4;
 - ⑤ Enter F805 parameter and set rated rotary speed of the motor to 1440 rpm;

- ⑥ Enter F800 parameter and set it to 1 to allow measuring the parameter of the motor
 - ⑦ Press the “Run” key, to measure the parameters of the motor. After completion of the measurement, and relevant parameters will be stored in F806. For the details of measurement of motor parameters, please refer to “Operation process of measuring the motor parameters” in this manual and Chapter XII of this manual.
- (4) Set functional parameters of the inverter:
- ① Enter F203 parameter and set it to 0;
 - ② Enter F111 parameter and set the frequency to 50.00Hz;
 - ③ Enter F200 parameter and set it to 0; select the mode of start as keypad control;
 - ④ Enter F201 parameter and set it to 0; select the mode of stop as keypad control;
 - ⑤ Enter F202 parameter and set it to 0; select forward locking.
- (5) Press the “Run” key, to start the inverter;
- (6) During running, current frequency of the inverter can be changed by pressing ▲ or ▼;
- (7) Press the “Stop/Reset” key once, the motor will decelerate until it stops running;
- (8) Switch off the air switch, and power off the inverter.

4.9.2 Operation process of setting the frequency with keypad panel, and starting, forward and reverse running, and stopping inverter through control terminals

- (1) Connect the wires in accordance with Figure 4-2. After having checked the wiring successfully, switch on the air switch, and power on the inverter;

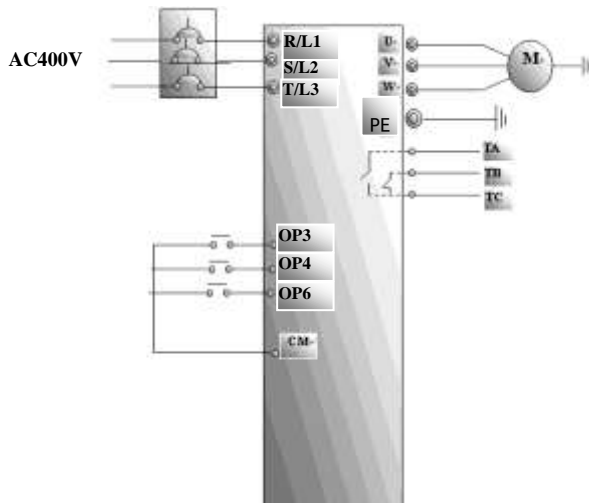

Figure 4-2 Wiring Diagram 2

- (2) Press the “Fun” key, to enter the programming menu.
- (3) Study the parameters of the motor: the operation process is the same as that of example 1.
- (4) Set functional parameters of the inverter:
- ① Enter F203 parameter and set it to 0; select the mode of frequency setting to digital given memory;
 - ② Enter F111 parameter and set the frequency to 50.00Hz;
 - ③ Enter F208 parameter and set it to 1; select two-line control mode 1 (Note: when F208 ≠ 0, F200, F201 and F202 will be invalid.)
- (5) Close the switch OP3, the inverter starts forward running;
- (6) During running, current frequency of the inverter can be changed by pressing ▲ or ▼;

(7) During running, switch off the switch OP3, then close the switch OP4, the running direction of the motor will be changed (Note: The user should set the dead time of forward and reverse running F120 on the basis of the load. If it was too short, OC protection of the inverter may occur.)

(8) Switch off the switches OP3 and OP4, the motor will decelerate until it stops running;

(9) Switch off the air switch, and power off the inverter.

4.9.3 Operation process of jogging operation with keypad panel

(1) Connect the wires in accordance with Figure 4-1. After having checked the wiring successfully, switch on the air switch, and power on the inverter;

(2) Press the “Fun” key, to enter the programming menu.

(3) Study the parameters of the motor: the operation process is the same as that of example 1.

(4) Set functional parameters of the inverter:

① Enter F132 parameter and set it to 1; select keypad jogging;

② Enter F200 parameter and set it to 0; select the mode of running command control as keypad operation;

③ Enter F124 parameter, and set the jogging operation frequency to 5.00Hz;

④ Enter F125 parameter, and set the jogging acceleration time to 30S;

⑤ Enter F126 parameter, and set the jogging deceleration time to 30S;

⑥ Enter F202 parameter, and set it to 0; select forward running locking.

(5) Press and hold the “Run” key until the motor is accelerated to the jogging frequency, and maintain the status of jogging operation.

(6) Release the “Run” key. The motor will decelerate until jogging operation is stopped;

(7) Switch off the air switch, and power off the inverter.

4.9.4 Operation process of setting the frequency with analog terminal and controlling the operation with control terminals

(1) Connect the wires in accordance with Figure 4-3. After having checked the wiring successfully, switch on the air switch, and power on the inverter. Note: 2K~5K potentiometer may be adopted for setting external analog signals. For the cases with higher requirements for precision, please adopt precise multiturn potentiometer, and adopt shielded wire for the wire connection, with near end of the shielding layer grounded reliably.

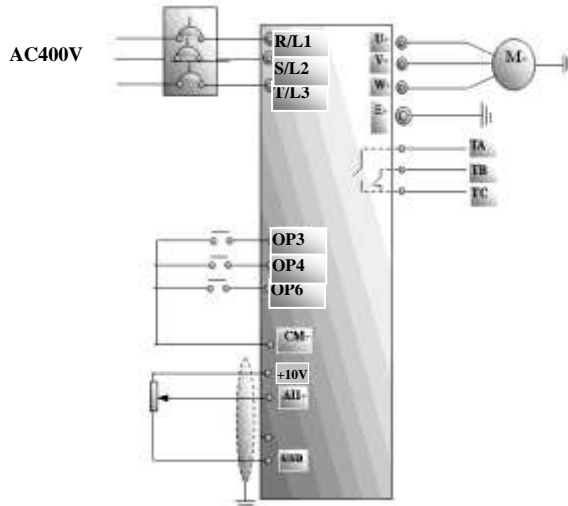
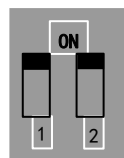

Figure 4-3 Wiring Diagram 3

- (2) Press the “Fun” key, to enter the programming menu.
- (3) Study the parameters of the motor: the operation process is the same as that of example 1.
- (4) Set functional parameters of the inverter:
 - ① Enter F203 parameter, and set it to 1; select the mode of frequency setting of analog AI1, 0~10V voltage terminal;
 - ② Enter F208 parameter, and set it to 1; select direction terminal (set OP6 to free stop, set OP3 to forward running, set OP4 to reverse running) to control running;

(5) There is a red two-digit coding switch SW1 near the control terminal block of 15 KW inverter and below 15kw , as shown in Figure 4-4. The function of coding switch is to select the voltage signal (0~5V/0~10V) or current signal of analog input terminal AI2, current channel is default. In actual application, select the analog input channel through F203. Turn switches 1 to ON and 2 to ON as illustrated in the figure, and select 0~20mA current speed control. Another switches states and mode of control speed are as table 4-2.



SW1

Fig 4-4

(6) There is a red four-digit coding switch SW1 near the control terminal block of above 15 KW inverter, as shown in Figure 4-5. The function of coding switch is to select the input range (0~5V/0~10V/0~20mA) of analog input terminal AI1 and AI2. In actual application, select the analog input channel through F203. AI1 channel default value is 0~10V, AI2 channel default value is 0~20mA. Another switches states and mode of control speed are as table 4-3.

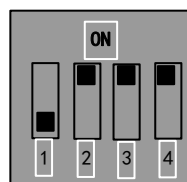

SW1

Fig 4-5

- (7) Close the switch OP3, the motor starts forward running;
- (8) The potentiometer can be adjusted and set during running, and the current setting frequency of the inverter can be changed;
- (9) During running, switch off the switch OP3, then, close OP4, the running direction of the motor will be changed;
- (10) Switch off the switches OP3 and OP4, the motor will decelerate until it stops running;
- (11) Switch off the air switch, and power off the inverter.

Table 4-2 The Setting of Coding Switch and Parameters in the Mode of Analog Speed Control

Set F203 to 2, to select channel AI2		
Coding Switch 1	Coding Switch 2	Mode of Speed Control
OFF	OFF	0~5V voltage
OFF	ON	0~10V voltage
ON	ON	0~20mA current

ON refers to switching the coding switch to the top.

OFF refers to switching the coding switch to the bottom.

Table 4-3

Set F203 to 1, to select channel AI1			Set F203 to 2, to select channel AI2		
Coding Switch 1	Coding Switch 3	Analog signal range	Coding Switch 2	Coding Switch 4	Analog signal range
OFF	OFF	0~5V voltage	OFF	OFF	0~5V voltage
OFF	ON	0~10V voltage	OFF	ON	0~10V voltage
ON	ON	0~20mA current	ON	ON	0~20mA current
ON refers to switching the coding switch to the top.					
OFF refers to switching the coding switch to the bottom.					

V. Function Parameters

5.1 Basic parameters

F100	User's Password	Setting range: 0~9999	Mfr's value: 8
------	-----------------	-----------------------	----------------

·When F107=1 with valid password, the user must enter correct user's password after power on or fault reset if you intend to change parameters. Otherwise, parameter setting will not be possible, and a prompt "Err1" will be displayed.

Relating function code: F107 Password valid or not

F108 Setting user's password

F102	Inverter's Rated Current (A)	Setting range: 1.0~800.0	Mfr's value: Subject to inverter model
F103	Inverter Power (KW)	Setting range: 0.2~500.0	Mfr's value: Subject to inverter model

·Rated current and rated power can only be checked but cannot be modified.

F105	Software Edition No.	Setting range: 1.00~10.00	Mfr's value: Subject to inverter model
------	----------------------	---------------------------	--

Softward Edition No. can only be checked but cannot be modified.

F107	Password Valid or Not	Setting range: 0: invalid; 1: valid	Mfr's value: 0
F108	Setting User's Password	Setting range: 0~9999	Mfr's value: 8

When F107 is set to 0, the function codes can be changed without inputting the password. When F107 is set to 1, the function codes can be changed only after inputting the user's password by F100.

·The user can change "User's Password". The operation process is the same as those of changing other parameters.

· Input the value of F108 into F100, and the user's password can be unlocked.

Note: When password protection is valid, and if the user's password is not entered, F108 will display 0.

F109	Starting Frequency (Hz)	Setting range: 0.00~10.00	Mfr's value: 0.00 Hz
F110	Holding Time of Starting Frequency (S)	Setting range: 0.0~10.0	Mfr's value: 0.0

The inverter begins to run from the starting frequency. If the target frequency is lower than starting frequency, F109 is invalid.

The inverter begins to run from the starting frequency. After it keeps running at the starting frequency for the time as set in F110, it will accelerate to target frequency. The holding time is not included in acceleration/deceleration time.

Starting frequency is not limited by the Min frequency set by F112. If the starting frequency set by F109 is lower than Min frequency set by F112, inverter will start according to the setting parameters set by F109 and F110. After inverter starts and runs normally, the frequency will be limited by frequency set by F111 and F112.

Starting frequency should be lower than Max frequency set by F111.

If starting frequency is lower than target frequency set by F113, starting frequency will be invalid.

F111 Max Frequency (Hz)	Setting range: F113~650.0	Mfr's value: 50.00Hz
F112 Min Frequency (Hz)	Setting range: 0.00~F113	Mfr's value: 0.50Hz

·Max frequency is set by F111.

·Min frequency is set by F112.

·The setting value of min frequency should be lower than target frequency set by F113.

·The inverter begins to run from the starting frequency. During inverter running, if the given frequency is lower than min frequency, then inverter will run at min frequency until inverter stops or given frequency is higher than min frequency.

Max/Min frequency should be set according to the nameplate parameters and running situations of motor. The motor is forbidden running at low frequency for a long time, or else motor will be damaged because of overheat.

F113 Target Frequency (Hz)	Setting range: F112~F111	Mfr's value: 50.00Hz
----------------------------	--------------------------	----------------------

It shows the preset frequency. Under keypad speed control or terminal speed control mode, the inverter will run to this frequency automatically after startup.

F114 First Acceleration Time (S)	Setting range: 0.1~3000S	Mfr's value: For 0.2~3.7KW, 5.0S For 5.5~30KW, 30.0S For above 37KW, 60.0S
F115 First Deceleration Time (S)		
F116 Second Acceleration Time (S)		Mfr's value: For 0.2~3.7KW, 8.0S For 5.5~30KW, 50.0S For above 37KW, 90.0S
F117 Second Deceleration Time (S)		

Acceleration Time: The time for inverter to accelerate from 0Hz to 50Hz^{Note1}

Deceleration Time: The time for inverter to decelerate from 50Hz to 0Hz^{Note1}

The reference of setting accel/decel time is set by F119.

·The second Acceleration/Deceleration time can be chosen by multifunction digital input terminals F316~F323. Set the value of function code to 18 and select the second acceleration/Deceleration time by connecting OP terminal with CM terminal.

F119 The reference of setting accel/decel time	Setting range: 0: 0~50.00Hz 1: 0~max frequency	Mfr's value: 0
--	---	----------------

When F119=0, acceleration/ deceleration time means the time for inverter to accelerate/ decelerate from 0Hz (50Hz) to 50Hz (0Hz).

When F119=1, acceleration/ deceleration time means the time for inverter to accelerate/ decelerate from 0Hz (max frequency) to max frequency (0Hz).

F118 Turnover Frequency (Hz)	Setting range: 15.00~650.0	Mfr's value: 50.00Hz
------------------------------	----------------------------	----------------------

·Turnover frequency is the final frequency of V/F curve, and also is the least frequency according to the highest output voltage.

·When running frequency is lower than this value, inverter has constant-torque output. When running frequency exceeds this value, inverter has constant-power output.

F120 Forward / Reverse Switchover dead-Time (S)	Setting range: 0.0~3000	Mfr's value: 0.00S
---	-------------------------	--------------------

· Within "forward/ reverse switchover dead-time", this latency time will be cancelled and the inverter will switch to run in the other direction immediately upon receiving "stop" signal. This function is suitable for all the speed control modes except automatic cycle operation.

·This function can ease the current impact in the process of direction switchover.

F122 Reverse Running Forbidden	Setting range: 0: invalid; 1: valid	Mfr's value: 0
--------------------------------	-------------------------------------	----------------

When F122=1, inverter will only run forward no matter the state of terminals and the parameters set by F202.

Inverter will not run reverse and forward / reverse switchover is forbidden. If reverse signal is given, inverter will stop.

F123 Minus frequency is valid in the mode of combined speed control.	0: Invalid; 1: valid	0
--	----------------------	---

In the mode of combined speed control, if running frequency is minus and F123=0, inverter willrun at 0Hz; if F123=1, inverter will run reverse at this frequency. (This function is controlled by F122.)

F124 Jogging Frequency (Hz)	Setting range: F112~F111	Mfr's value: 5.00Hz
F125 Jogging Acceleration Time (S)	Setting range: 0.1~3000	Mfr's value: For 0.2~3.7KW, 5.0S For 5.5~30KW, 30.0S For above 37KW, 60.0S
F126 Jogging Deceleration Time (S)		

There are two types of jogging: keypad jogging and terminal jogging. Keypad jogging is valid only under stopped status (F132 including of displaying items of keypad jogging should be set). Terminal jogging is valid under both running status and stopped status.

Carry out jogging operation through the keypad (under stopped status):

- Press the “Fun” key, it will display “HF-0”;
- Press the “Run” key, the inverter will run to “jogging frequency” (if pressing “Fun” key again, “keypad jogging” will be cancelled).

· In case of terminal jogging, make “jogging” terminal (such as OP1) connected to CM, and inverter will run to jogging frequency. The rated function codes are from F316 to F323.

- Jogging Acceleration Time: the time for inverter to accelerate from 0Hz to 50Hz.
- Jogging Deceleration Time: the time for inverter to decelerate from 50Hz to 0Hz.

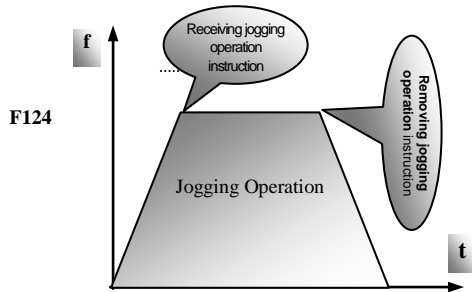

Figure 5-1 Jogging Operation

F127/F129 Skip Frequency A,B (Hz)	Setting range: 0.00~650.0	Mfr's value:0.00Hz
F128/F130 Skip Width A,B (Hz)	Setting range: ±2.5	Mfr's value: 0.0

· Systematic vibration may occur when the motor is running at a certain frequency. This parameter is set to skip this frequency.

The inverter will skip the point automatically when output frequency is equal to the set value of this parameter.

“Skip Width” is the span from the upper to the lower limits around Skip Frequency. For example, Skip Frequency=20Hz, Skip Width=±0.5Hz, inverter will skip automatically when output is between 19.5~20.5Hz.

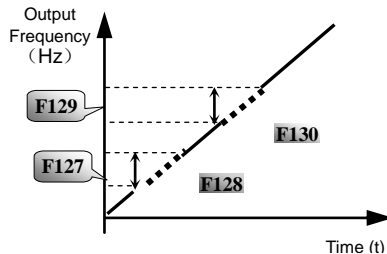

Figure 5-2 Skip Frequency

Inverter will not skip this frequency span during acceleration/deceleration.

F131 Running Display Items	0—Current output frequency/function-code 1—Output rotary speed 2—Output current 4—Output voltage 8—PN voltage 16—PID feedback value 32—Temperature 64—Count values 128—Linear speed	Mfr's value: 0+1+2+4+8=15
----------------------------	---	------------------------------

·Single-phase 0.2~0.75KW inverters have no the function of temperature display.

Selection of one value from 1, 2, 4, 8, 16, 32, 64 and 128 shows that only one specific display item is selected. Should multiple display items be intended, add the values of the corresponding display items and take the total values as the set value of F131, e.g., just set F131 to be 19 (1+2+16) if you want to call “current output rotary speed”, “output current” and “PID feedback value”. The other display items will be covered.

As F131=255, all display items are visible, of which, “frequency/function-code” will be visible whether or not it is selected.

Should you intend to check any display item, just press the “Fun” key for switchover.

Refer to the following table for each specific value unit and its indication:

Whatever the value of F131 is set to, corresponding target frequency will flash under stopped status.

Target rotary speed is an integral number. If it exceeds 9999, add a decimal point to it.

Current display A *.*

Voltage display U***

Count value *.*

Temperature H***

Linear speed L***.

If it exceeds 999, add a decimal point to it. If it exceeds 9999, add two decimal points to it, and the like.

F132 Display items of stop	Setting range: 0: Frequency/function-code 1: Keypad jogging 2: Target rotary speed 4: PN voltage 8: PID feedback value 16: Temperature 32: Count values	Mfr's value: 0+2+4=6
F133 Drive ratio of driven system	Setting range: 0.10~200.0	Mfr's value: 1.00
F134 Transmission-wheel radius	0.001~1.000 (m)	Mfr's value: 0.001

Calculation of rotary speed and linear speed:

For example, If inverter's max frequency F111=50.00Hz, numbers of motor poles F804=4, drive ratio F133=1.00, transmission-shaft radius R=0.05m, then

Transmission shaft perimeter: $2\pi r = 2 \times 3.14 \times 0.05 = 0.314$ (meter)

Transmission shaft rotary speed: $60 \times \text{operation frequency} / (\text{numbers of poles pairs} \times \text{drive ratio})$
 $= 60 \times 50 / (2 \times 1.00) = 1500 \text{rpm}$

Endmost linear speed: $\text{rotary speed} \times \text{perimeter} = 1500 \times 0.314 = 471 \text{ (meters/second)}$

F136	Slip compensation	Setting range: 0~10%	Mfr's value: 0
------	-------------------	----------------------	----------------

· Under V/F controlling, rotary speed of motor rotor will decrease as load increases. Be assured that rotor rotate speed is near to synchronization rotary speed while motor with rated load, slip compensation should be adopted according to the setting value of frequency compensation.

F137	Modes of torque compensation	Setting range: 0: Linear compensation; 1: Square compensation; 2: User-defined multipoint compensation 3: Auto torque compensation	Mfr's value: 3
F138	Linear compensation	Setting range: 1~16	Mfr's value: 0.2-3.7: 5 5.5-30: 4 Above 37: 3
F139	Square compensation	Setting range: 1: 1.5 2: 1.8 3: 1.9 4: 2.0	Mfr's value: 1

To compensate low-frequency torque controlled by V/F, output voltage of inverter while low-frequency should be compensated.

When F137=0, linear compensation is chosen and it is applied on universal constant-torque load;

When F137=1, square compensation is chose and it is applied on the loads of fan or water pump;

When F137=2, user-defined multipoint compensation is chosen and it is applied on the special loads of spin-drier or centrifuge;

This parameter should be increased when the load is heavier, and this parameter should be decreased when the load is lighter.

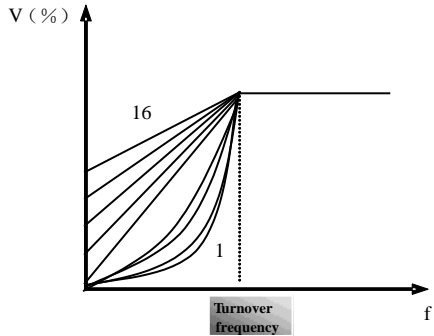

Fig 5-3 Torque Promotion

If the torque is elevated too much, motor is easy to overheat, and the current of inverter will be too high. Please check the motor while elevating the torque.

When F137=3, auto torque compensation is chose and it can compensate low-frequency torque automatically, to diminish motor slip, to make rotor rotary speed close to synchro rotary speed and to restrain motor vibration. Customers should set correctly motor power, rotary speed, numbers of motor poles, motor rated current and stator resistance. Please refer to the chapter “Operation process of measuring motor stator resistance parameters”.

F140	User-defined frequency point F1	Setting range: 0~F142	Mfr's value: 1.00
F141	User-defined voltage point V1	Setting range: 0~100%	Mfr's value: 4

F142	User-defined frequency point F2	Setting range: F140~F144	Mfr's value: 5.00
F143	User-defined voltage point V2	Setting range: 0~100%	Mfr's value: 13
F144	User-defined frequency point F3	Setting range: F142~F146	Mfr's value: 10.00
F145	User-defined voltage point V3	Setting range: 0~100%	Mfr's value: 24
F146	User-defined frequency point F4	Setting range: F144~F148	Mfr's value: 20.00
F147	User-defined voltage point V4	Setting range: 0~100%	Mfr's value: 45
F148	User-defined frequency point F5	Setting range: F146~F150	Mfr's value: 30.00
F149	User-defined voltage point V5	Setting range: 0~100%	Mfr's value: 63
F150	User-defined frequency point F6	Setting range: F148~F118	Mfr's value: 40.00
F151	User-defined voltage point V6	Setting range: 0~100%	Mfr's value: 81

Multi-stage V/F curves are defined by 12 parameters from F140 to F151.

The setting value of V/F curve is set by motor load characteristic.

Note: $V1 < V2 < V3 < V4 < V5 < V6$, $F1 < F2 < F3 < F4 < F5 < F6$. As low-frequency, if the setting voltage is too high, motor will overheat or be damaged. Inverter will be stalling or occur over-current protection.

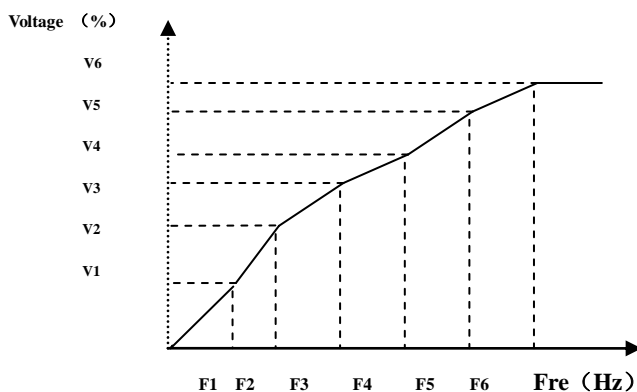

Fig 5-4 Polygonal-Line Type V/F

F152 Output voltage corresponding to turnover frequency	Setting range: 10~100%	Mfr's value: 100
---	------------------------	------------------

This function can meet the needs of some special loads, for example, when the frequency outputs 300Hz and corresponding voltage outputs 200V (supposed voltage of inverter power supply is 380V), turnover frequency F118 should be set to 300Hz and F152 is set to $(200 \div 380) \times 100 = 52.6$. And F152 should be equal to the integer value 53.

Please take care nameplate parameters of motor. If the working voltage is higher than rated voltage or the frequency is higher than rated frequency, motor would be damaged.

F153 Carrier frequency setting	Setting range:	Mfr's value:
	0.2~7.5KW: 2~10K	4K
	11~15KW: 2~10K	3K
	18.5KW~45KW: 2~6K	4K
	Above 55KW: 2~4K	2K

Carrier-wave frequency of inverter is adjusted by setting this code function. Adjusting carrier-wave may reduce motor noise, avoid point of resonance of mechanical system, decrease leakage current of wire to earth and the interference of inverter.

When carrier-wave frequency is low, although carrier-wave noise from motor will increase, the current leaked to the earth will decrease. The wastage of motor and the temperature of motor will increase, but the temperature of inverter will decrease.

When carrier-wave frequency is high, the situations are opposite, and the interference will raise.

When output frequency of inverter is adjusted to high frequency, the setting value of carrier-wave should be increased. Performance is influenced by adjusting carrier-wave frequency as below table:

Carrier-wave frequency	Low → High
Motor noise	Loud → Low
Waveform of output current	Bad → Good
Motor temperature	High → Low
Inverter temperature	Low → High
Leakage current	Low → High
Interference	Low → High

F154 Automatic voltage rectification	Setting range: 0: Invalid 1: Valid 2:Invalid during deceleration process	Mfr's value: 0
--------------------------------------	---	----------------

This function is enable to keep output voltage constant automatically in the case of fluctuation of input voltage, but the deceleration time will be affected by internal PI adjustor. If deceleration time is forbidden being changed, please select F154=2.

F155 Digital accessory frequency setting	Setting range: 0~F111	Mfr's value: 0
F156 Digital accessory frequency polarity setting	Setting range: 0 or 1	Mfr's value: 0
F157 Reading accessory frequency		
F158 Reading accessory frequency polarity		

Under combined speed control mode, when accessory frequency source is digital setting memory (F204=0), F155 and F156 are considered as initial set values of accessory frequency and polarity (direction).

In the mode of combined speed control, F157 and F158 are used for reading the value and direction of accessory frequency.

For example, when F203=1, F204=0. F207=1, the given analog frequency is 15Hz, inverter is required to run to 20Hz. In case of this requirement, user can push "UP" button to raise the frequency from 15Hz to 20Hz. User can also set F155=5Hz and F160=0 (0 means forward, 1 means reverse). In this way, inverter can be run to 20Hz directly.

F159 Random carrier-wave selection	Setting range: 0: Not allowed 1: allowed	Mfr's value: 1
------------------------------------	--	----------------

When F159=0, inverter will modulate as per the carrier-wave set by F153. When F159=1, inverter will operate in mode of random carrier-wave modulating.

Note: when random carrier-wave is selected, output torque will increase but noise will be loud. When the

carrier-wave set by F153 is selected, noise will be reduced, but output torque will decrease. Please set the value according to the situation.

F160 Reverting to manufacturer values	Setting range: 0: Not reverting to manufacturer values; 1: Reverting to manufacturer values	Mfr's value: 0
---------------------------------------	---	----------------

When there is disorder with inverter's parameters and manufacturer values need to be restored, set F160=1. After "Reverting to manufacturer values" is done, F160 values will be automatically changed to 0.

· "Reverting to manufacturer values" will not work for the function-codes marked "o" in the "change" column of the parameters table. These function codes have been adjusted properly before delivery. And it is recommended not to change them.

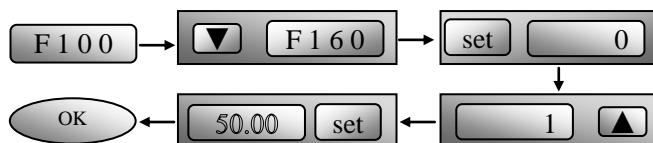

Figure 5-3 Reverting to manufacturer values

5.2 Operation Control

F200 Source of start command	Setting range: 0: Keypad command; 1: Terminal command; 2: Keypad+Terminal; 3: MODBUS; 4: Keypad+Terminal+MODBUS	Mfr's value: 0
F201 Source of stop command	Setting range: 0: Keypad command; 1: Terminal command; 2: Keypad+Terminal; 3: MODBUS; 4: Keypad+Terminal+MODBUS	Mfr's value: 0

·F200 and F201 are the resource of selecting inverter control commands.

·Inverter control commands include: starting, stopping, forward running, reverse running, jogging, etc.

·"Keypad command" refers to the start/stop commands given by the "Run" or "stop/reset" key on the keypad.

·"Terminal command" refers to the start/stop command given by the "Run" terminal defined by F316-F323.

When F200=3 and F201=3, the running command is given by MODBUS communication.

When F200=2 and F201=2, "keypad command" and "terminal command" are valid at the mean time, F200=4 and F201=4 are the same.

F202 Mode of direction setting	Setting range: 0: Forward running locking; 1: Reverse running locking; 2: Terminal setting	Mfr's value: 0
-----------------------------------	---	----------------

·The running direction is controlled by this function code together with other speed control mode which can set the running direction of inverter. When auto-circulation speed is selected by F500=2, this function code is not valid.

·When speed control mode without controlling direction is selected, the running direction of inverter is controlled by this function code, for example, keypad controls speed.

·When speed control mode with controlling direction is selected, the running direction of inverter is controlled by both modes. The way is polarity addition, for example, one forward direction and one reverse direction make the inverter run reversely, both forward directions make inverter run forward, both reverse directions which equal to forward direction make inverter run forward.

F203 Main frequency source X	Setting range: 0: Memory of digital given; 1: External analog AI1; 2: External analog AI2; 3: Pulse input given; 4: Stage speed control; 5: No memory of digital given; 6: Keypad potentiometer; 7: Reserved; 8: Reserved; 9: PID adjusting; 10: MODBUS	Mfr's value: 0
---------------------------------	---	----------------

·Main frequency source is set by this function code.

0: Memory of digital given

Its initial value is the value of F113. The frequency can be adjusted through the key “up” or “down”, or through the “up”, “down” terminals.

“Memory of digital given” means after inverter stops, the target frequency is the running frequency before stop. If the user would like to save target frequency in memory when the power is disconnected, please set F220=1, i.e. frequency memory after power-down is valid.

1: External analog AI1; 2: External analog AI2

The frequency is set by analog input terminal AI1 and AI2. The analog signal may be current signal (0-20mA or 4-20mA) or voltage signal (0-5V or 0-10V), which can be chosen by switch code. Please adjust the switch code according to practical situations, refer to fig 4-4 and table 4-2.

When inverters leave the factory, the analog signal of AI1 channel is DC voltage signal, the range of voltage is 0-10V, and the analog signal of AI2 channel is DC current signal, the range of current is 0-20 mA. If 4-20mA current signal is needed, please set lower limit of analog input F406=2, which input resistor is 500OHM. If some errors exist, please make some adjustments.

3: Pulse input given

When frequency is given by pulse input, the pulse is only input by OP1 terminal. The max pulse frequency is 50K. The related function code are F440~F446.

4: Stage speed control

Multi-stage speed control is selected by setting stage speed terminals F316-F322 and function codes of multi-stage speed section. The frequency is set by multi-stage terminal or automatic cycling frequency.

5: No memory of digital given

Its initial value is the value of F113. The frequency can be adjusted through the key “up” or “down”, or through the “up”, “down” terminals.

“No memory of digital given” means that the target frequency will restore to the value of F113 after stop no matter the state of F220.

6: Keypad Potentiometer AI3

The frequency is set by the potentiometer on the control panel.

9: PID adjusting

When PID adjusting is selected, the running frequency of inverter is the value of frequency adjusted by PID. Please refer to instructions of PID parameters for PID given resource, PID given numbers, feedback source, and so on.

10: MODBUS

The main frequency is given by MODBUS communication.

F204 Accessorial frequency source Y	Setting range: 0: Memory of digital given; 1: External analog AI1; 2: External analog AI2; 3: Pulse input given; 4: Stage speed control; 5: PID adjusting; 6: Keypad potentiometer AI3	Mfr's value: 0
-------------------------------------	--	----------------

· When accessorial frequency Y is given to channel as independent frequency, it has the same function with main frequency source X.

· When F204=0, the initial value of accessorial frequency is set by F155. When accessorial frequency controls speed independently, polarity setting F156 is not valid.

· When F207=1 or 3, and F204=0, the initial value of accessorial frequency is set by F155, the polarity of accessorial

frequency is set by F156, the initial value of accessorial frequency and the polarity of accessorial frequency can be checked by F157 and F158.

·When the accessorial frequency is given by analog input (AI1, AI2), the setting range for the accessorial frequency is set by F205 and F206.

When the accessorial frequency is given by keypad potentiometer, the main frequency can only select stage speed control and modbus control (F203=4, 10)

·Note: accessorial frequency source Y and main frequency source X can not be same, i.e., they can not use the same frequency given channel.

F205 Reference for selecting accessorial frequency source Y range	Setting range: 0: Relative to max frequency; 1: Relative to frequency X	Mfr's value: 0
F206 Accessorial frequency Y range	Setting range: 0~100%	Mfr's value: 100

·When combined speed control is adopted for frequency source, F206 is used to confirm the relative object of the setting range for the accessorial frequency.

F205 is to confirm the reference of the accessorial frequency range. If it is relative to main frequency, the range will change according to the change of main frequency X.

F207 Frequency source selecting	Setting range: 0: X; 1: X+Y; 2: X or Y (terminal switchover); 3: X or X+Y (terminal switchover); 4: Combination of stage speed and analog 5: X-Y 6: X+(Y-50%)	Mfr's value: 0
---------------------------------	--	----------------

Select the channel of setting the frequency. The frequency is given by combination of main frequency X and accessorial frequency Y.

·When F207=0, the frequency is set by main frequency source.

·When F207=1, X+Y, the frequency is set by adding main frequency source to accessorial frequency source. X or Y can not be given by PID.

·When F207=2, main frequency source and accessorial frequency source can be switched over by frequency source switching terminal.

·When F207=3, main frequency given and adding frequency given(X+Y) can be switched over by frequency source switching terminal. X or Y can not be given by PID.

·When F207=4, stage speed setting of main frequency source has priority over analog setting of accessorial frequency source (only suitable for F203=4 F204=1).

·When F207=5, X-Y, the frequency is set by subtracting accessorial frequency source from main frequency source. If the frequency is set by main frequency or accessorial frequency, PID speed control can not be selected.

·When F207=6, X+(Y-50%), the frequency is given by both main frequency source and accessorial frequency source. X or Y can not be given by PID.

Note:

1. When F203=4 and F204=1, the difference between F207=1 and F207=4 is that when F207=1, frequency source selecting is the addition of stage speed and analog, when F207=4, frequency source selecting is stage speed with stage speed and analog given at the same time. If stage speed given is canceled and

- analog given still exists, inverter will run by analog given.
2. Frequency given mode can be switched over by selecting F207. For example: switching PID adjusting and normal speed control, switching stage speed and analog given, switching PID adjusting and analog given, and so on.
 3. The acceleration/deceleration time of stage speed is set by function code of corresponding stage speed time. When combined speed control is adopted for frequency source, the acceleration/deceleration time is set by F114 and F115.
 4. When stage speed control is valid, the accel/decel time of stage speed is executed firstly. After inverter is powered on and stage speed control is invalid, the time of F114 and F115 is executed. If stage speed signal is cancelled in the process of running, the accel/decel time of stage speed is also valid.
 5. The mode of automatic cycle speed control is unable to combine with other modes.
 6. When F207=2 (main frequency source and accessory frequency source can be switched over by terminals), if main frequency is not set to be under stage-speed control, accessory frequency can be set to be under automatic cycle speed control (F204=5, F500=0). Through the defined switchover terminal, the control mode (defined by X) and automatic cycle speed control (defined by Y) can be freely switched.
 7. If the settings of main frequency and accessory frequency are the same, only main frequency will be valid.
 8. When F207=6, F205=0 and F206=100, then $X + (Y-50\%) = X + (100\% - 50\%) * F111$. when F207=6, F205=1 and F206=100, then $X + (Y-50\%) = X + (100\% - 50\%) * X$.

F208 Terminal two-line/three-line operation control	Setting range: 0: other type; 1: Two-line operation mode 1; 2: Two-line operation mode 2; 3: three-line operation mode 1; 4: three-line operation mode 2; 5: start/stop controlled by direction pulse	Mfr's value: 0
--	---	----------------

·When selecting two-line type or three-line type), F200, F201 and F202 are invalid.

·Five modes are available for terminal operation control.

Note:

In case of stage speed control, set F208 to 0. If F208 ≠0 (when selecting two-line type or three-line type), F200, F201 and F202 are invalid.

“FWD”, “REV” and “X” are three terminals designated in programming OP1 ~OP6.

1: Two-line operation mode 1: this mode is the most popularly used two-line mode. The running direction of mode is controlled by FWD, REV terminals.

For example: “FWD” terminal-----“open”: stop, “closed”: forward running;

“REV” terminal-----“open”: stop, “closed”: reverse running;

“CM” terminal-----common port

K1	K2	Running command
0	0	Stop
1	0	Forward running
0	1	Reverse running
1	1	Stop

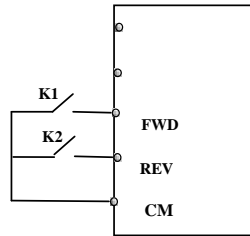

2. Two-line operation mode 2: when this mode is used, FWD is enable terminal, the direction is controlled by REV terminal.

For example: “FWD” terminal-----“open”: stop, “closed”: running;

“REV” terminal-----“open”: forward running, “closed”: reverse running;

“CM” terminal-----common port

K1	K2	Running command
0	0	Stop
0	1	Stop
1	0	Forward running
1	1	Reverse running

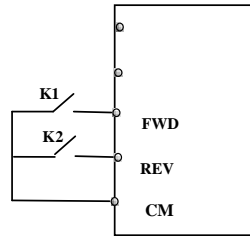

3. Three-line operation mode 1:

In this mode, X terminal is enable terminal, the direction is controlled by FWD terminal and REV terminal. Pulse signal is valid. Stopping command is enable by opening X terminal.

SB3: stop button

SB2: forward button

SB1: reverse button

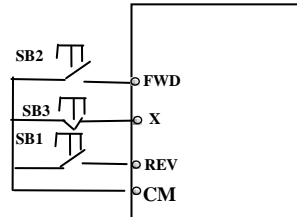

4. Three-line operation mode 2:

In this mode, X terminal is enable terminal, running command is controlled by FWD terminal. The running direction is controlled by REV terminal, and stopping command is enable by opening X terminal.

SB1: Running button

SB2: Stop button

K1: direction switch. Open stands for forward running; close stands for reverse running.

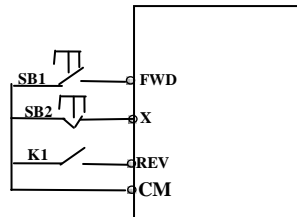

5. Start/stop controlled by direction pulse:

“FWD” terminal—(impulse signal: forward/stop)

“REV” terminal—(impulse signal: reverse/stop)

“CM” terminal—common port

Note: when pulse of SB1 triggers, inverter will run forward. When the pulse triggers again, inverter will stop running.

When pulse of SB2 triggers, inverter will run reverse. When the pulse triggers again, inverter will stop running.

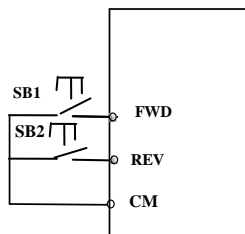

F209	Selecting the mode of stopping the motor	Setting range: 0: stop by deceleration time; 1: free stop	Mfr's value: 0
------	--	--	----------------

When the stop signal is input, stopping mode is set by this function code:

F209=0: stop by deceleration time

Inverter will decrease output frequency according to setting acceleration/deceleration curve and decelerating time, after frequency decreases to 0, inverter will stop. This is common used stopping type.

F209=1: free stop

After stop command is valid, inverter will stop output. Motor will free stop by mechanical inertia.

F210	Frequency display accuracy	Setting range: 0.01~2.00	Mfr's value: 0.01
------	----------------------------	--------------------------	-------------------

Under keypad speed control or terminal UP/DOWN speed control, frequency display accuracy is set by this function code and the range is from 0.01 to 2.00. For example, when F210=0.5, UP/DOWN terminal is pressed at one time, frequency will increase or decrease by 0.5Hz.

This function is valid when inverter is in the running state. When inverter is in the standby state, no matter what value of this function code is, frequency will increase or decrease by 0.01Hz.

F211	Speed of digital speed control	Setting range: 0.01~100.0Hz/S	Mfr's value: 5.00
------	--------------------------------	-------------------------------	-------------------

When UP/DOWN terminal is pressed, frequency will change at the setting rate. The Mfr's value is 5.00Hz/s.

F212	Direction memory	Setting range: 0: Invalid 1: Valid	Mfr's value: 0
------	------------------	------------------------------------	----------------

·This function is valid when three-line operation mode 1(F208=3) is valid.

·When F212=0, after inverter is stopped, resetted and repowered on, the running direction is not memorized.

· When F212=1, after inverter is stopped, resetted and repowered on, if inverter starts running but no direction signal, inverter will run according the memoried direction.

F213	Selfstarting after repowered on	Setting range: 0: invalid; 1: valid	Mfr's value: 0
------	---------------------------------	-------------------------------------	----------------

F214	Selfstarting after reset	Setting range: 0: invalid; 1: valid	Mfr's value: 0
------	--------------------------	-------------------------------------	----------------

Whether or not to start automatically after repowered on is set by F213

F213=1, Selfstarting after repowered on is valid. When inverter is power off and then powered on again, it will run automatically after the time set by F215 and according to the running mode before power-down. If F220=0 frequency memory after power-down is not valid, inverter will run by the setting value of F113.

F213=0, after repower-on, inverter will not run automatically unless running command is given to inverter.

Whether or not to start automatically after fault resetting is set by F214

When F214=1, if fault occurs, inverter will reset automatically after delay time for fault reset (F217). After resetting, inverter will run automatically after the selfstarting delay time (F215).

If frequency memory after power-down (F220) is valid, inverter will run at the speed before power-down. Otherwise, inverter will run at the speed set by F113.

In case of fault under running status, inverter will reset automatically and self-start. In case of fault under

stopped status, the inverter will only reset automatically.

When F214=0, after fault occurs, inverter will display fault code, it must be reset manually.

F215	Selfstarting delay time	Setting range: 0.1~3000.0	Mfr's value: 60.0
------	-------------------------	---------------------------	-------------------

F215 is the selfstarting delay time for F213 and F214. The range is from 0.1s to 3000.0s.

F216	Times of selfstarting in case of repeated faults	Setting range: 0~5	Mfr's value: 0
F217	Delay time for fault reset	Setting range: 0.0~10.0	Mfr's value: 3.0

F216 sets the most times of selfstarting in case of repeated faults. If starting times are more than the setting value of this function code, inverter will not reset or start automatically after fault. Inverter will run after running command is given to inverter manually.

F217 sets delay time for fault reset. The range is from 0.0 to 10.0S which is time interval from fault to resetting.

F220	Frequency memory after power-down	Setting range: 0: invalid; 1: valid	Mfr's value: 0
------	-----------------------------------	-------------------------------------	----------------

F220 sets whether or not frequency memory after power-down is valid.

This function is valid for F213 and F214. Whether or not to memory running state after power-down or malfunction is set by this function.

The function of frequency memory after power-down is valid for main frequency and accessorial frequency that is given by digital. Because the accessorial frequency of digital given has positive polarity and negative polarity, it is saved in the function codes F155 and F156.

F222	count memory selection	Setting range: 0: Invalid 1: Valid	Mfr's value: 0
------	------------------------	------------------------------------	----------------

F220 sets whether or not count memory is valid. Whether or not to memory counting values after power-down or malfunction is set by this function.

Table 5-1 Combination of Speed Control

F204 \ F203	0. Memory of digital setting	1 External analog AI1	2 External analog AI2	3 Pulse input given	4 Terminal stage speed control	5 PID adjusting	6 Keypad potentiometer AI3
0 Memory of Digital setting	○	●	●	●	●	●	○
1 External analog AI1	●	○	●	●	●	●	○
2 External analog AI2	●	●	○	●	●	●	○
3 Pulse input given	●	●	●	○	●	●	○
4 Terminal Stage speed control	●	●	●	●	○	●	●
5 Digital setting	○	●	●	●	●	●	○
6 Keypad potentiometer AI3	●	●	●	●	●	●	○
9 PID adjusting	●	●	●	●	●	○	○
10 MODBUS	●	●	●	●	●	●	●

●: Intercombination is allowable.

○: Combination is not allowable.

The mode of automatic cycle speed control is unable to combine with other modes. If the combination includes the mode of automatic cycle speed control, only main speed control mode will be valid.

5.3. Multifunctional Input and Output Terminals

5.3.1 Digital multifunctional output terminals

F300	Relay token output	Setting range: 0~18	Mfr's value: 1
F301	DO1 token output		Mfr's value: 14
F302	DO2 token output	Refer to table 5-2 for detailed instructions.	Mfr's value: 5

E1000 inverter has one multifunctional relay output terminal. Inverters of 15KW and below 15KW have one multifunctional digital output terminals (without DO2 terminal), inverters above 15KW have two multifunctional digital output terminals.

Table 5-2 Instructions for digital multifunctional output terminal

Value	Function	Instructions
0	no function	Output terminal has no functions.
1	inverter fault protection	When inverter works wrong, ON signal is output.
2	over latent frequency 1	Please refer to instructions from F307 to F309.
3	over latent frequency 2	Please refer to instructions from F307 to F309.
4	free stop	Under free stop status, after stop command is given, ON signal is output until inverter completely stops.
5	in running status 1	Indicating that inverter is running and ON signal is output.
6	DC braking	Indicating that inverter is in the status of DC braking and ON signal is output.
7	acceleration/deceleration time switchover	Indicating that inverter is in the status of acceleration/deceleration time switchover
8	Reaching the Set Count Value	This terminal will be "action" when inverter carries the external count instruction and count value reaches the set value of F314.
9	Reaching the Designated Count Value	This terminal will be "action" when inverter carries the external count instruction and count value reaches the set value of F315.
10	inverter overload pre-alarm	After inverter overloads, ON signal is output after the half time of protection timed, ON signal stops outputting after overload stops or overload protection occurs.
11	motor overload pre-alarm	After motor overloads, ON signal is output after the half time of protection timed, ON signal stops outputting after overload stops or overload protection occurs.
12	stalling	During accel/deccl process, inverter stops accelerating/decelerating because inverter is stalling, and ON signal is output.
13	Inverter is ready to run	When inverter is powered on. Protection function is not in action and inverter is ready to run, then ON signal is output.
14	In running status 2	Indicating that inverter is running and ON signal is output. When inverter is running at 0HZ, it seems as the running status, and ON signal is output.
15	frequency arrival output	Indicating inverter runs to the setting target frequency, and ON signal is output. See F312.
16	overheat pre-alarm	When testing temperature reaches 80% of setting value, ON signal is output. When overheat protection occurs or testing value is lower than 80%of setting value, ON signal stops outputting.

17	over latent current output	When output current of inverter reaches the setting overlatent current, ON signal is output. See F310 and F311.
18	reserved	reserved

F303 DO output types selection	Setting range: 0: level output : pulse output	Mfr's value: 0
--------------------------------	---	----------------

· When level output is selected, all terminal functions in table 5-2 can be defined by F301.

· When pulse output is selected, DO1 can be defined as high-speed pulse output terminal. The max pulse frequency is 50KHz. The related function codes are F449, F450, F451, F452, F453.

F307 Characteristic frequency 1	Setting range: F112~F111Hz	Mfr's value: 10Hz
F308 Characteristic frequency 2		Mfr's value: 50Hz
F309 Characteristic frequency width	Setting range: 0~100%	Mfr's value: 50

When F300 and F301=2,3 and token characteristic frequency is selected, this group function codes set characteristic frequency and its width.

For example: setting F301=2, F307=10, F309=10, when running frequency is greater than or equal to F307, DO1 will be in action. When running frequency is lower than $(10-10*10\%) = 9\text{Hz}$, DO1 will be disconnected.

F310 Characteristic current	Setting range: 0~1000A	Mfr's value: Rated current
F311 Characteristic current width	Setting range: 0~100%	Mfr's value: 10

When F300, F301 and F302=17 and token characteristic current is selected, this group function codes set characteristic current and its width.

For example: setting F301=17, F310=100, F311=10, when current of inverter is greater than or equal to F310, DO1 will be in action. When inverter current is lower than $(100-100*10\%) = 90\text{A}$, DO1 will be disconnected.

F312 Frequency arrival threshold	Setting range: 0.00~5.00Hz	Mfr's value: 0.00
----------------------------------	----------------------------	-------------------

When F300=15 and F301=15, threshold range is set by F312.

For example: when F301=15, target frequency is 20HZ and F312=2, the running frequency reaches 18Hz (20-2), ON signal is output by DO1 until the running frequency reaches target frequency.

F313 Count frequency divisions	Setting range: 1~65000	Mfr's value: 1
F314 Set count values	Setting range: F315~65000	Mfr's value: 1000
F315 Designated count values	Setting range: 1~F314	Mfr's value : 500

• Count frequency divisions refer to the ratio of actual pulse input and inverter's count times, i.e.,

$$\text{Inverter's Count Times} = \frac{\text{Actual Pulse Input}}{\text{Count Frequency Division}}$$

e.g. when F313=3, inverter will count once for every 3 inputs of external pulse.

• Set count values refer to a count width pulse output by the output terminal (DO1 terminal or relay) programmed with "reaching the set count values" function when a certain number of pulses are input from OP1. Count will restart after the count value reaches "set times".

As shown in Fig 5-6: if F313=1, F314=8, F301=8, DO1 will output an instruction signal when OP1

inputs the 8th pulse.

- Designated count values refer to an pulse output by the output terminal (DO1 or RELAY terminal) programmed with “reaching the set count values” function when a certain number of pulses are input from OP1, until count value reaches the “set times”.

As shown in Fig 5-6: if F313=1, F314=8, F315=5, F300=9, relay will output an instruction signal when OP1 inputs the 5th pulse, relay will output an instruction signal until reaching “set count times 8”.

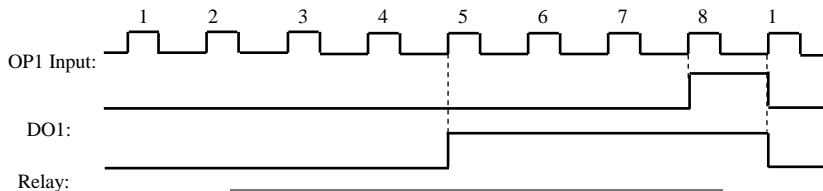

Fig 5-6 Set Count times & Designated Count Times

5.3.2 Digital multifunctional input terminals

F316	OP1 terminal function setting	Setting range: 0: no function; 1: running terminal; 2: stop terminal; 3: multi-stage speed terminal 1; 4: multi-stage speed terminal 2; 5: multi-stage speed terminal 3; 6: multi-stage speed terminal 4; 7: reset terminal; 8: free stop terminal; 9: external emergency stop terminal; 10: acceleration/deceleration forbidden terminal; 11: forward run jogging; 12: reverse run jogging; 13: UP frequency increasing terminal; 14: DOWN frequency decreasing terminal; 15: “FWD” terminal; 16: “REV” terminal; 17: three-line type input “X” terminal; 18: acceleration/deceleration time switchover terminal; 19~20: Reserved; 21: frequency source switchover terminal; 22: Count input terminal; 23: Count reset terminal; 24~30: reserved	Mfr's value: 11
F317	OP2 terminal function setting		Mfr's value: 9
F318	OP3 terminal function setting		Mfr's value: 15
F319	OP4 terminal function setting		Mfr's value: 16
F320	OP5 terminal function setting		Mfr's value: 7
F321	OP6 terminal function setting		Mfr's value: 8
F322	OP7 terminal function setting		Mfr's value: 1
F323	OP8 terminal function setting		Mfr's value: 2

This parameter is used for setting the corresponding function for multifunctional digital input terminal.

Both free stop and external emergency stop of the terminal have the highest priority.

When pulse given is selected, OP1 terminal is set as pulse signal input terminal automatically.

Note: 15KW inverter and below 15KW has 6 multifunctional digital input terminals OP1-OP6.

Table 5-3 Instructions for digital multifunctional input terminal

Value	Function	Instructions
0	No function	Even if signal is input, inverter will not work. This function can be set by undefined terminal to prevent mistake action.
1	Running terminal	When running command is given by terminal or terminals combination and this terminal is valid, inverter will run. This terminal has the same function with "run" key in keypad.
2	Stop terminal	When stop command is given by terminal or terminals combination and this terminal is valid, inverter will stop. This terminal has the same function with "stop" key in keypad.
3	Multi-stage speed terminal 1	15-stage speed is realized by combination of this group of terminals. See table 5-4.
4	Multi-stage speed terminal 2	
5	Multi-stage speed terminal 3	
6	Multi-stage speed terminal 4	
7	Reset terminal	This terminal has the same function with "reset" key in keypad. Long-distance malfunction reset can be realized by this function.
8	Free stop terminal	Inverter closes off output and motor stop process is not controlled by inverter. This mode is often used when load has big inertia or there are no requirements for stop time. This mode has the same function with free stop of F209.
9	External emergency stop terminal	When external malfunction signal is given to inverter, malfunction will occur and inverter will stop.
10	Acceleration/deceleration forbidden terminal	Inverter will not be controlled by external signal (except for stop command), and it will run at the current output frequency.
11	forward run jogging	Forward jogging running and reverse jogging running. Refer to F124, F125 and F126 for jogging running frequency, jogging acceleration/deceleration time.
12	reverse run jogging	
13	UP frequency increasing terminal	When frequency source is set by digital given, the setting frequency can be adjusted which rate is set by F211.
14	DOWN frequency decreasing terminal	
15	"FWD" terminal	When start/stop command is given by terminal or terminals combination, running direction of inverter is controlled by external terminals.
16	"REV" terminal	
17	Three-line input "X" terminal	"FWD", "REV", "CM" terminals realize three-line control. See F208 for details.
18	acceleration/deceleration time switchover terminal	When this function is selected, second acceleration/deceleration time is valid. See F116 and F117 for the second acceleration/deceleration time.
19	Reserved	Reserved
20	Reserved	Reserved
21	frequency source switchover terminal	When F207=2, main frequency source(X) and accessory frequency source(Y) can be switched over by frequency source switching terminal. When F207=3, X and (X + Y) can be switched over by frequency source switching terminal.
22	Count input terminal	Built-in count pulse input terminal.
23	Count reset terminal	Reset terminal count value to zero.
24-30	Reserved	Reserved

Table 5-4 Instructions for multistage speed

K4	K3	K2	K1	Frequency setting	Parameters
0	0	0	0	None	None
0	0	0	1	Multi-stage speed 1	F504/F519/F534/F549/F557/F565
0	0	1	0	Multi-stage speed 2	F505/F520/F535/F550/F558/F566
0	0	1	1	Multi-stage speed 3	F506/F521/F536/F551/F559/F567
0	1	0	0	Multi-stage speed 4	F507/F522/F537/F552/F560/F568
0	1	0	1	Multi-stage speed 5	F508/F523/F538/F553/F561/F569
0	1	1	0	Multi-stage speed 6	F509/F524/F539/F554/F562/F570
0	1	1	1	Multi-stage speed 7	F510/F525/F540/F555/F563/F571
1	0	0	0	Multi-stage speed 8	F511/F526/F541/F556/F564/F572
1	0	0	1	Multi-stage speed 9	F512/F527/F542/F573
1	0	1	0	Multi-stage speed 10	F513/F528/F543/F574
1	0	1	1	Multi-stage speed 11	F514/F529/F544/F575
1	1	0	0	Multi-stage speed 12	F515/F530/F545/F576
1	1	0	1	Multi-stage speed 13	F516/F531/F546/F577
1	1	1	0	Multi-stage speed 14	F517/F532/F547/F578
1	1	1	1	Multi-stage speed 15	F518/F533/F548/F579

Note: K4 is multi-stage speed terminal 4, K3 is multi-stage speed terminal 3, K2 is multi-stage speed terminal 2, K1 is multi-stage speed terminal 1. And 0 stands for OFF, 1 stands for ON.

F324 Free stop terminal logic	Setting range: 0: positive logic (valid for low level); 1: negative logic (valid for high level)	Mfr's value: 0
F325 External emergency stop terminal logic		Mfr's value: 0
F328 Terminal filtering times	Setting range: 1~100	Mfr's value: 10

When multi-stage speed terminal is set to free stop terminal (8) or external emergency stop terminal (9), logic level is set by this group of function codes. When F324=0 and F325=0, positive logic and low level is valid, when F324=1 and F325=1, negative logic and high level is valid.

5.4 Analog Input and Output

E1000 series inverters have 2 analog input channels and 2 analog output channels. AI3 input channel is inside input channel for potentiometer on the keypad panel.

F400	Lower limit of AI1 channel input	Setting range: 0.00~F402	Mfr's value: 0.01V
F401	Corresponding setting for lower limit of AI1 input	Setting range: 0~F403	Mfr's value: 1.00
F402	Upper limit of AI1 channel input	Setting range: F400~10.00V	Mfr's value: 10.00V

F403	Corresponding setting for upper limit of AII input	Setting range: Max (1.00, F401) ~2.00	Mfr's value: 2.00
F404	AII channel proportional gain K1	Setting range: 0.0~10.0	Mfr's value: 1.0
F405	AII filtering time constant	Setting range: 0.1~10.00	Mfr's value: 0.10

In the mode of analog speed control, sometimes it requires adjusting coincidence relation among upper limit and lower limit of input analog, analog changes and output frequency, to achieve a satisfactory speed control effect.

·Upper and lower limit of analog input are set by F400 and F402.

For example: when F400=1, F402=8, if analog input voltage is lower than 1V, system judges it as 0. If input voltage is higher than 8V, system judges it as 10V (Suppose analog channel selects 0-10V). If Max frequency F111 is set to 50Hz, the output frequency corresponding to 1-8V is 0-50Hz.

·The filtering time constant is set by F405.

The greater the filtering time constant is, the more stable for the analog testing. However, the precision may decrease to a certain extent. It may require appropriate adjustment according to actual application.

·Channel proportional gain is set by F404.

If 1V corresponds to 10Hz and F404=2, then 1V will correspond to 20Hz.

·Corresponding setting for upper / lower limit of analog input are set by F401 and F403.

If Max frequency F111 is 50Hz, analog input voltage 0-10V can correspond to output frequency from -50Hz to 50Hz by setting this group function codes. Please set F401=0 and F403=2, then 0V corresponds to -50Hz, 5V corresponds to 0Hz and 10V corresponds to 50Hz. The unit of corresponding setting for upper / lower limit of input is in percentage (%). If the value is greater than 1.00, it is positive; if the value is less than 1.00, it is negative. (e.g. F401=0.5 represents -50%).

If the running direction is set to forward running by F202, then 0-5V corresponding to the minus frequency will cause reverse running, or vice versa.

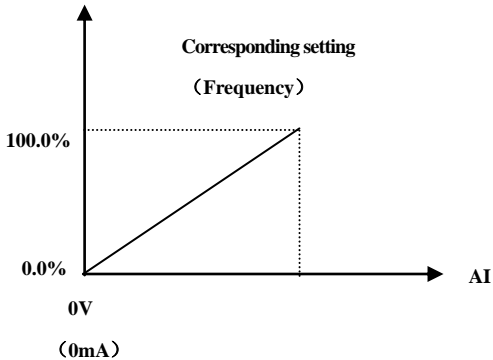

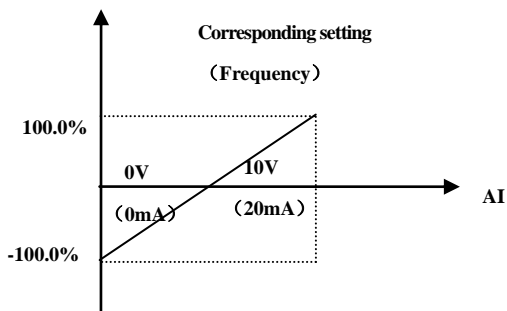
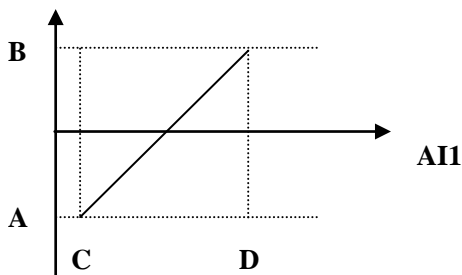

Fig 5-6 correspondence of analog input to setting

The unit of corresponding setting for upper / lower limit of input is in percentage (%). If the value is greater than 1.00, it is positive; if the value is less than 1.00, it is negative. (e.g. F401=0.5 represents -50%). The corresponding setting benchmark: in the mode of combined speed control, analog is the accessory frequency and the setting benchmark for range of accessory frequency which relates to main frequency (F205=1) is “main frequency X”; corresponding setting benchmark for other cases is the “max frequency”, as illustrated in the right figure:



$$A = (F401-1) * \text{setting value}$$

$$B = (F403-1) * \text{setting value}$$

$$C = F400$$

$$D = F402$$

F406	Lower limit of AI2 channel input	Setting range: 0.00~F408	Mfr's value: 0.01V
F407	Corresponding setting for lower limit of AI2 input	Setting range: 0~F409	Mfr's value: 1.00
F408	Upper limit of AI2 channel input	Setting range: F406~10.00V	Mfr's value: 10.00V
F409	Corresponding setting for upper limit of AI2 input	Setting range: Max (1.00, F407) ~2.00	Mfr's value: 2.00
F410	AI2 channel proportional gain K2	Setting range: 0.0~10.0	Mfr's value: 1.0
F411	AI2 filtering time constant	Setting range: 0.1~10.00	Mfr's value: 0.10
F412	Lower limit of AI3 channel input	Setting range: 0.00~F414	Mfr's value: 0.05V
F413	Corresponding setting for lower limit of AI3 input	Setting range: 0~F415	Mfr's value: 1.00

F414	Upper limit of AI3 channel input	Setting range: F412~10.0V	Mfr's value: 10.0V
F415	Corresponding setting for upper limit of AI3 input	Setting range: Max (1.00, F413) ~2.00	Mfr's value: 2.00
F416	AI3 channel proportional gain K1	Setting range: 0.0~10.0	Mfr's value: 1.0
F417	AI3 filtering time constant	Setting range: 0.1~10.00	Mfr's value: 0.10

The function of AI2 and AI3 is the same with AI1.

F418	AI1 channel 0Hz voltage dead zone	Setting range: 0~0.50V (Positive-Negative)	Mfr's value: 0.00
F419	AI2 channel 0Hz voltage dead zone	Setting range: 0~0.50V (Positive-Negative)	Mfr's value: 0.00
F420	AI3 channel 0Hz voltage dead zone	Setting range: 0~0.50V (Positive-Negative)	Mfr's value: 0.00

Analog input voltage 0-5V can correspond to output frequency -50Hz-50Hz (2.5V corresponds to 0Hz) by setting the function of corresponding setting for upper / lower limit of analog input. The group function codes of F418, F419 and F420 set the voltage range corresponding to 0Hz. For example, when F418=0.5, F419=0.5 and F420=0.5, the voltage range from (2.5-0.5=2) to (2.5+0.5=3) corresponds to 0Hz. So if F418=N, F419=N and F420=N, then $2.5 \pm N$ should correspond to 0Hz. If the voltage is in this range, inverter will output 0Hz. 0HZ voltage dead zone will be valid when corresponding setting for lower limit of input is less than 1.00. E1000 series inverters have two analog output channels.

F437	Analog filter width	Setting range: 1~100	Mfr's value:10
------	---------------------	----------------------	----------------

The greater the setting value of F437 is, the steadier the detecting analog is, but the response speed will decrease. Please set it according to the actual situations.

F460	AI1 channel input mode	Setting range: 0: straight line mode 1: folding line mode	Mfr's value: 0
F461	AI2 channel input mode	Setting range: 0: straight line mode 1: folding line mode	Mfr's value: 0
F462	AI1 insertion point A1 voltage value	Setting range: F400~F464	Mfr's value: 2.00V
F463	AI1 insertion point A1 setting value	Setting range: F401~F465	Mfr's value: 1.40
F464	AI1 insertion point A2 voltage value	Setting range: F462~F466	Mfr's value: 3.00V
F465	AI1 insertion point A2 setting value	Setting range: F463~F467	Mfr's value: 1.60
F466	AI1 insertion point A3 voltage value	Setting range: F464~F402	Mfr's value: 4.00V
F467	AI1 insertion point A3 setting value	Setting range: F465~F403	Mfr's value: 1.80
F468	AI2 insertion point B1 voltage value	Setting range: F406~F470	Mfr's value: 2.00V
F469	AI2 insertion point B1 setting value	Setting range: F407~F471	Mfr's value: 1.40
F470	AI2 insertion point B2 voltage value	Setting range: F468~F472	Mfr's value: 3.00V
F471	AI2 insertion point B2 setting value	Setting range: F469~F473	Mfr's value: 1.60
F472	AI2 insertion point B3 voltage value	Setting range: F470~F412	Mfr's value: 4.00V
F473	AI2 insertion point B3 setting value	Setting range: F471~F413	Mfr's value: 1.80

When analog channel input mode selects straight-line, please set it according to the parameters from F400 to

F429. When folding line mode is selected, three points A1(B1) , A2(B2), A3(B3) are inserted into the straight line, each of which can set the according frequency to input voltage. Please refer to the following figure:

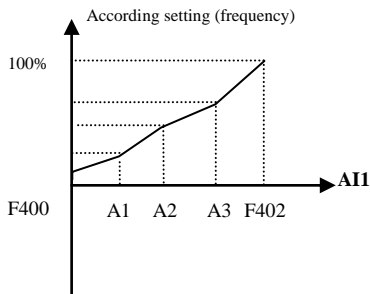

Fig 5-9 Folding analog with setting value

F400 and F402 are lower/upper limit of analog AI1 input. When F460=1, F462=2.00V, F463=1.4, F111=50, F203=1, F207=0, then A1 point corresponding frequency is $(F463-1) * F111=20\text{Hz}$, which means 2.00V corresponding to 20Hz. The other points can be set by the same way.

AI2 channel has the same setting way as AI1.

F423	AO1 output range selecting	Setting range: 0: 0~5V; 1: 0~10V	Mfr's value: 1
F424	Corresponding frequency for lowest voltage of AO1 output	Setting range: 0.0~F425	Mfr's value: 0.05Hz
F425	Corresponding frequency for highest voltage of AO1 output	Setting range: F424~F111	Mfr's value: 50.00Hz
F426	AO1 output compensation	Setting range: 0~120%	Mfr's value: 100

· AO1 output range is selected by F423. When F423=0, AO1 output range selects 0~5V, and when F423=1, AO1 output range selects 0~10V.

· Correspondence of output voltage range (0-5V or 0-10V) to output frequency is set by F424 and F425. For example, when F423=0, F424=10 and F425=120, analog channel AO1 outputs 0-5V and the output frequency is 10-120Hz.

· AO1 output compensation is set by F426. Analog excursion can be compensated by setting F426.

F427	AO2 output range	Setting range: 0: 0~20mA; 1: 4~20 mA	Mfr's value: 0
F428	AO2 lowest corresponding frequency	Setting range: 0.0~F429	Mfr's value: 0.05Hz
F429	AO2 highest corresponding frequency	Setting range: F428~F111	Mfr's value: 50.00
F430	AO2 output compensation	Setting range: 0~120%	Mfr's value: 100

The function of AO2 is the same as AO1, but AO2 will output current signal, current signal of 0-20mA and 4-20mA could be selected by F427.

F431	AO1 analog output signal selecting	Setting range: 0: Running frequency;	Mfr's value: 0
------	------------------------------------	---	----------------

F432	AO2 analog output signal selecting	1: Output current; 2: Output voltage; 3~5: Reserved	Mfr's value: 1
------	------------------------------------	---	----------------

·Token contents output by analog channel are selected by F431 and F432. Token contents include running frequency, output current and output voltage.

·When output current is selected, analog output signal is from 0 to twofold rated current.

·When output voltage is selected, analog output signal is from 0V to rated output voltage (230V or 400V).

F433	Corresponding current for full range of external voltmeter	Setting range: 0.01~5.00 times of rated current	Mfr's value: 2.00
F434	Corresponding current for full range of external ammeter		Mfr's value: 2.00

·In case of F431=1 and AO1 channel for token current, F433 is the ratio of measurement range of external voltage type ammeter to rated current of the inverter.

·In case of F432=1 and AO2 channel for token current, F434 is the ratio of measurement range of external current type ammeter to rated current of the inverter.

For example: measurement range of external ammeter is 20A, and rated current of the inverter is 8A, then, $F433=20/8=2.50$.

5.5 Pulse input/output

F440	Min frequency of input pulse FI	Setting range: 0.00~F442	Mfr's value: 0.00K
F441	Corresponding setting of FI min frequency	Setting range:0.00~F443	Mfr's value: 1.00
F442	Max frequency of input pulse FI	Setting range: F440~50.00K	Mfr's value: 10.00K
F443	Corresponding setting of FI max frequency	Setting range: Max (1.00 , F441) ~2.00	Mfr's value: 2.00
F445	Filtering constant of FI input pulse	Setting range: 0~100	Mfr's value: 0
F446	FI channel 0Hz frequency dead zone	Setting range: 0~F442 (Positive-Negative)	Mfr's value: 0.00

Min frequency of input pulse is set by F440 and max frequency of input pulse is set by F442.

For example: when F440=0K and F442=10K, and the max frequency is set to 50Hz, then input pulse frequency 0-10K corresponds to output frequency 0-50Hz.

Filtering time constant of input pulse is set by F445.

The greater the filtering time constant is, the more steady pulse measurement, but precision will be lower, so please adjust it according to the application situation.

Corresponding setting of min frequency is set by F441 and corresponding setting of max frequency is set by F443.

When the max frequency is set to 50Hz, pulse input 0-10K can corresponds to output frequency -50Hz-50Hz by setting this group function codes. Please set F441 to 0 and F443 to 2, then 0K corresponds to -50Hz, 5K corresponds to 0Hz, and 10K corresponds to 50Hz. The unit of corresponding setting for max/min pulse frequency is in percentage (%). If the value is greater than 1.00, it is positive; if the value is less than 1.00, it is negative.

If the running direction is set to forward by F202, then 0-5K corresponding to the minus frequency will cause reverse running, or vice versa.

·0 Hz frequency dead zone is set by F446.

Input pulse 0-10K can correspond to output frequency -50Hz~50Hz (5K corresponds to 0Hz) by setting the function of corresponding setting for max/min input pulse frequency. The function code F446 sets the input pulse range corresponding to 0Hz. For example, when $F446=0.5$, the pulse range from $(5K-0.5K=4.5K)$ to $(5K+0.5K=5.5K)$ corresponds to 0Hz. So if $F446=N$, then $5\pm N$ should correspond to 0Hz. If the pulse is in this range, inverter will output 0Hz.

0Hz voltage dead zone will be valid when corresponding setting for min pulse frequency is less than 1.00.

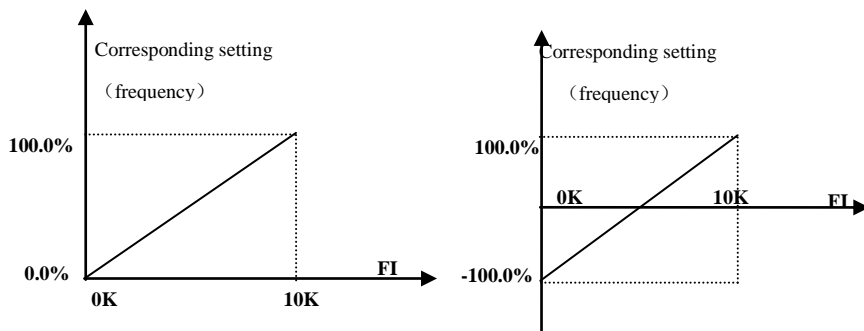

Fig 5-10 correspondence of pulse input and setting

The unit of corresponding setting for max/min input pulse frequency is in percentage (%). If the value is greater than 1.00, it is positive; if the value is less than 1.00, it is negative. (e.g. $F441=0.5$ represents -50%). The corresponding setting benchmark: in the mode of combined speed control, pulse input is the accessorial frequency and the setting benchmark for range of accessorial frequency which relates to main frequency ($F205=1$) is "main frequency X"; corresponding setting benchmark for other cases is the "max frequency", as illustrated in the right figure:

$$A=(F441-1)*\text{setting benchmark}$$

$$B=(F443-1)*\text{setting benchmark}$$

$$C= F440$$

$$F= F442$$

$$(E-D)/2=F446$$

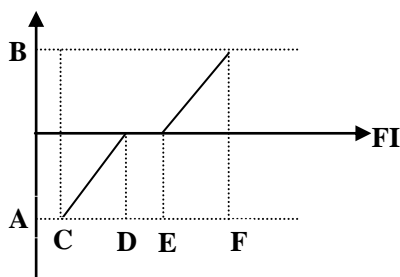

Fig 5-11 Pulse input and setting value

F449 Max frequency of output pulse FO	Setting range: 0.00~50.00K	Mfr's value: 10.00K
F450 Zero drift coefficient of output pulse frequency	Setting range: 0.0~100.0%	Mfr's value: 0.0%
F451 Frequency gain of output pulse	Setting range: 0.00~10.00	Mfr's value: 1.00

F453 Output pulse signal	Setting range: 0: Running frequency 1: Output current 2: Output voltage 3~5: reserved	Mfr's value: 0
--------------------------	---	----------------

· When DO1 is defined as high-speed pulse output terminal, the max frequency of output pulse is set by F449.

If “b” stands for zero drift coefficient, “k” stands for gain, “Y” stands for actual output of pulse frequency and “X” stands for standard output, then $Y=Kx+b$.

Standard output X is the token value corresponding to output pulse min/max frequency, which range is from zero to max value.

100 percent of zero drift coefficient of output pulse frequency corresponds to the max output pulse frequency (the set value of F449.)

Frequency gain of output pulse is set by F451. User can set it to compensate the deviation of output pulse.

Output pulse token object is set by F453. For example: running frequency, output current and output voltage, etc.

When output current is displayed, the range of token output is 0-2 times of rated current.

When output voltage is displayed, the range of token output is from 0 to rated output voltage.

5.6 Multi-stage Speed Control

The function of multi-stage speed control is equivalent to a built-in PLC in the inverter. This function can set running time, running direction and running frequency.

E1000 series inverter can realize 15-stage speed auto circulating and 8-stage speed auto circulating.

F500 Stage speed type	Setting range: 0: 3-stage speed; 1: 15-stage speed; 2: Max 8-stage speed auto circulating	Mfr's value: 1
-----------------------	---	----------------

In case of multi-stage speed control (F203=4), the user must select a mode by F500. When F500=0, 3-stage speed is selected. When F500=1, 15-stage speed is selected. When F500=2, max 8-stage speed auto circulating is selected. When F500=2, “auto circulating” is classified into “2-stage speed auto circulating”, “3-stage speed auto circulating”, ... “8-stage speed auto circulating”, which is to be set by F501.

Table 5-5 Selection of Stage Speed Running Mode

F203	F500	Mode of Running	Description
4	0	3-stage speed control	The priority in turn is stage-1 speed, stage-2 speed and stage-3 speed. It can be combined with analog speed control. If F207=4, “3-stage speed control” is prior to analog speed control.
4	1	15-stage speed control	It can be combined with analog speed control. If F207=4, “15-stage speed control” is prior to analog speed control.
4	2	Max 8-stage speed auto circulating	Adjusting the running frequency manually is not allowable. “2-stage speed auto circulating”, “3-stage speed auto circulating”, ... “8-stage speed auto circulating” may be selected through setting the parameters.

F501 Selection of Stage Speed Under Auto-circulation Speed Control	Setting range: 2~8	Mfr's value: 7
--	--------------------	----------------

F502	Selection of Times of Auto-circulation Speed Control	Setting range: 0~9999 (when the value is set to 0, the inverter will carry out infinite circulating)	Mfr's value: 0
F503	Status After Auto-circulation Running Finished.	Setting range: 0: Stop 1: Keep running at last-stage speed	Mfr's value: 0

· If running mode is auto-circulation speed control (F203=4 and F500=2), please set the related parameters by F501~F503.

· That the inverter runs at the preset stage speed one by one under the auto-circulation speed control is called as “one time”.

· If F502=0, inverter will run at infinite auto circulation, which will be stopped by “stop” signal.

· If F502>0, inverter will run at auto circulation conditionally. When auto circulation of the preset times is finished continuously (set by F502), inverter will finish auto-circulation running conditionally. When inverter keeps running and the preset times is not finished, if inverter receives “stop command”, inverter will stop. If inverter receives “run command” again, inverter will auto circulate by the setting time by F502.

· If F503=0, then inverter will stop after auto circulation is finished. If F503=1, then inverter will run at the speed of the last-stage after auto-circulation is finished as follows:

e.g., F501=3, then inverter will run at auto circulation of 3-stage speed;

F502=100, then inverter will run 100 times of auto circulation;

F503=1, inverter will run at the speed of the last stage after the auto-circulation running is finished.

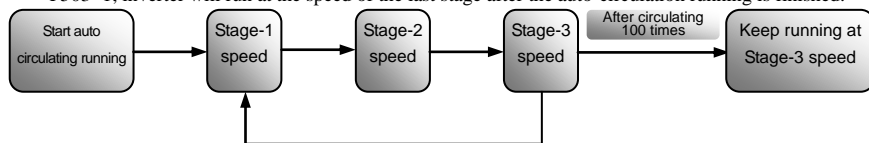

Figure 5-11 Auto-circulating Running

Then the inverter can be stopped by pressing “stop” or sending “stop” signal through terminal during auto-circulation running.

F504	Frequency setting for stage 1 speed	Setting range: F112~F111	Mfr's value: 5.00Hz
F505	Frequency setting for stage 2 speed		Mfr's value: 10.00Hz
F506	Frequency setting for stage 3 speed		Mfr's value: 15.00Hz
F507	Frequency setting for stage 4 speed		Mfr's value: 20.00Hz
F508	Frequency setting for stage 5 speed		Mfr's value: 25.00Hz
F509	Frequency setting for stage 6 speed		Mfr's value: 30.00Hz
F510	Frequency setting for stage 7 speed		Mfr's value: 35.00Hz
F511	Frequency setting for stage 8 speed		Mfr's value: 40.00Hz
F512	Frequency setting for stage 9 speed		Mfr's value: 5.00Hz
F513	Frequency setting for stage 10 speed		Mfr's value: 10.00Hz
F514	Frequency setting for stage 11 speed		Mfr's value: 15.00Hz
F515	Frequency setting for stage 12 speed		Mfr's value: 20.00Hz

F516	Frequency setting for stage 13 speed		Mfr's value: 25.00Hz
F517	Frequency setting for stage 14 speed		Mfr's value: 30.00Hz
F518	Frequency setting for stage 15 speed		Mfr's value: 35.00Hz
F519~F533	Acceleration time setting for the speeds from Stage 1 to Stage 15	Setting range: 0.1~3000S	Mfr's value: 0.2-3.7KW: 5.0S
F534~F548	Deceleration time setting for the speeds from Stage 1 to Stage 15	Setting range: 0.1~3000S	5.5-30KW: 30.0S Above 37KW: 60.0S
F549~F556	Running directions of stage speeds from Stage 1 to Stage 8	Setting range: 0: forward running; 1: reverse running	Mfr's value: 0
F573~F579	Running directions of stage speeds from stage 9 to stage 15	Setting range: 0: forward running; 1: reverse running	Mfr's value: 0
F557~564	Running time of stage speeds from Stage 1 to Stage 8	Setting range: 0.1~3000S	Mfr's value: 1.0S
F565~F572	Stop time after finishing stages from Stage 1 to Stage 8	Setting range: 0.0~3000S	Mfr's value: 0.0S

5.7 Auxiliary Functions

F600	DC Braking Function Selection	Setting range: 0: not allowed; 1: braking before starting; 2: braking during stopping; 3: braking during starting and stopping	Mfr's value: 0
F601	Initial Frequency for DC Braking	Setting range: 1.00~5.00	Mfr's value: 1.00
F602	DC Braking Voltage before Starting	Setting range: 0~60	Mfr's value: 10
F603	DC Braking Voltage During Stop		
F604	Braking Lasting Time Before Starting	Setting range: 0.0~10.0	Mfr's value: 0.5
F605	Braking Lasting Time During Stopping		

· When F600=0, DC braking function is not allowed.

· When F600=1, braking before starting is valid. After the right starting signal is input, inverter starts DC braking. After braking is finished, inverter will run from the initial frequency.

In some application occasion, such as fan, motor is running at a low speed or in a reverse status, if inverter starts immediately, OC malfunction will occur. Adopting “braking before starting” will ensure that the fan stays in a static state before starting to avoid this malfunction.

During braking before starting, if “stop” signal is given, inverter will stop by deceleration time.

When F600=2, DC braking during stopping is selected, after output frequency declines to initial frequency for DC braking, the rotating motor is stop by

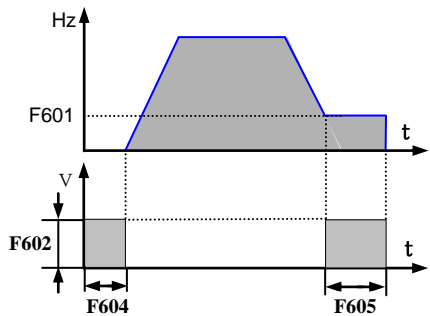

Figure 5-13 DC Braking

DC braking.

During the process of braking during stopping, if “start” signal is given, DC braking is finished and inverter will start.

If “stop” signal is given during the process of braking during stopping and inverter has no response, DC braking during stopping still goes on.

Parameters related to “DC Braking”: F601, F602, F604 and F605, interpreted as follows:

- F601: Initial frequency of DC-braking. DC braking will start to work as inverter’s output frequency is lower than this value.
- F602: DC braking voltage. The bigger value will result in a quick braking. However, motor will overheat with too big value.
- F604: Braking duration before starting. The time lasted for DC braking before inverter starts.
- F605: Braking duration when stopping. The time lasted for DC braking while inverter stops.

DC braking, as shown in Figure 5-9

Note: during DC braking, because motor does not have self-cold effect cause by rotating, it is in the state of easy over-heat. Please do not set DC braking voltage too high and do not set DC braking time to long.

F607	Selection of Stalling Adjusting Function	Setting range: 0: invalid; 1: valid	Mfr’s value: 0
F608	Stalling Current Adjusting (%)	Setting range: 60~200	Mfr’s value: 160
F609	Stalling Voltage Adjusting (%)	Setting range: 60~200	Mfr’s value: 140
F610	Stalling Protection Judging Time	Setting range: 0.1~3000.0	Mfr’s value: 5.0

Initial value of stalling current adjusting is set by F608, when the present current is higher than rated current *F608, stalling current adjusting function is valid.

During the process of deceleration, stalling current function is invalid.

During the process of acceleration, if output current is higher than initial value of stalling current adjusting and F607=1, then stalling adjusting function is valid. Inverter will not accelerate until the output current is lower than initial value of stalling current adjusting.

In case of stalling during stable speed running, the frequency will drop. If the current returns to normal during dropping, the frequency will return to rise. Otherwise, the frequency will keep dropping to the minimum frequency and the protection OL1 will occur after it lasts for the time as set in F610.

Initial value of stalling voltage adjusting is set by F609, when the present voltage is higher than rated voltage *F609, stalling voltage adjusting function is valid.

Stalling voltage adjusting is valid during the process of deceleration, including the deceleration process caused by stalling current.

Over-voltage means the DC bus voltage is too high and it is usually caused by decelerating. During the process of deceleration, DC bus voltage will increase because of energy feedback. When DC bus voltage is higher than the initial value of stalling voltage and F607=1, then stalling adjusting function is valid. Inverter will temporarily stop decelerating and keep output frequency constant, then inverter stops energy feedback. Inverter will not decelerate until DC bus voltage is lower than the initial value of stalling voltage.

Stalling protection judging time is set by F610. When inverter starts stalling adjusting function and continues the setting time of F610, inverter will stop running and OL1 protection occurs.

F611	Energy Consumption Brake Point	Setting range: 200~1000	Mfr’s value: Three-phase 710V Single-phase 380V
F612	Discharging percentage	Setting range: 0~100%	Mfr’s value: 80

Initial value of energy consumption brake point is set by F611, which of unit is V. When DC bus voltage is higher than the setting value of this function, energy consumption braking starts, braking unit starts working.

After DC bus voltage is lower than the setting value, braking unit stops working.
Discharging percentage of braking unit is set by F612, the range is 0~100%.

5.8. Malfunction and Protection

F700 Selection of terminal free stop mode	Setting range: 0: free stop immediately; 1: delayed free stop	Mfr's value: 0
F701 Delay time for free stop and programmable terminal action	Setting range: 0.0~60.0S	Mfr's value: 0.0

·“Selection of free stop mode” can be used only for the mode of “free stop” controlled by the terminal. The related parameters setting is F201=1, 2, 4 and F209=1.

When “free stop immediately” is selected, delay time (F701) will be invalid and inverter will free stop immediately.

·“Delayed free stop” means that upon receiving “free stop” signal, the inverter will execute “free stop” command after waiting some time instead of stopping immediately. Delay time is set by F701.

F702 Fan control mode	0:controlled by temperature 1: Do not controlled by temperature 2: controlled by running status	Mfr's value: 2
F703 Setting fan control temperature	Setting range: 0~100℃	Mfr's value: 35℃

When F702=0, fan will run if radiator's temperature is up to setting temperature which is set by F703.

When F702=1, fan will run when power is supplied to the inverter. And fan will not stop until inverter is powered off.

When F702=2, fan will run when inverter begins running. When inverter stops, fan will stop until radiator's temperature is lower than 45℃.

Fan control temperature is set by F703, the temperature is set by manufacture. User can only check it.

Single-phase 0.2~0.75kw inverters do not have this function, F702 and F703 are invalid

F704 Inverter Overloading pre-alarm Coefficient	Setting range: 50%~100%	Mfr's value: 80%
F705 Motor Overloading pre-alarm Coefficient	Setting range: 50%~100%	Mfr's value: 80%
F706 Inverter Overloading Coefficient %	Setting range: 120~190	Mfr's value: 150
F707 Motor Overloading Coefficient %	Setting range: 20~100	Mfr's value: 100

· Overloading Coefficient (F706): the ratio of overload-protection current and rated current, whose value shall be subject to actual load.

· Motor overloading coefficient (F707): when inverter drives lower power motor, please set the value of F707 by below formula in order to protect motor

$$\text{Motor Overloading Coefficient} = \frac{\text{Actual motor power}}{\text{Matching motor power}} \times 100\%$$

F708 Record of The Latest Malfunction Type	Setting range: 2: hardware over current (OC) 3: over voltage (OE) 4: input out-phase (PF1)	
F709 Record of Malfunction Type for Last but One		
F710 Record of Malfunction Type for Last but Two		

	5: inverter overload (OL1) 6: under voltage (LU) 7: overheat (OH) 8: motor overload (OL2) 11: external malfunction (ESP) 13. studying parameters without motor (Err2) 16: software over current (OC1) 17: output out-phase (PF0)	
F711	Fault Frequency of The Latest Malfunction	
F712	Fault Current of The Latest Malfunction	
F713	Fault PN End Voltage of The Latest Malfunction	
F714	Fault Frequency of Last Malfunction but One	
F715	Fault Current of Last Malfunction but One	
F716	Fault PN End Voltage of Last Malfunction but One	
F717	Fault Frequency of Last Malfunction but Two	
F718	Fault Current of Last Malfunction but Two	
F719	Fault PN End Voltage of Last Malfunction but Two	
F720	Record of overcurrent protection fault times	
F721	Record of overvoltage protection fault times	
F722	Record of overheat protection fault times	
F723	Record of overload protection fault times	
F724	Input out-phase	Setting range: 0: invalid; 1: valid Mfr's value: 1
F725	Undervoltage	Setting range: 0: invalid; 1: valid Mfr's value: 1
F726	Overheat	Setting range: 0: invalid; 1: valid Mfr's value: 1
F727	Output out-phase	Setting range: 0: invalid; 1: valid Mfr's value: 0
F728	Input out-phase filtering constant	Setting range: 0.1~60.0 Mfr's value: 0.5
F729	Undervoltage filtering constant	Setting range: 0.1~60.0 Mfr's value: 5.0
F730	Overheat protection filtering constant	Setting range: 0.1~60.0 Mfr's value: 5.0

“Undervoltage” refers to too low voltage at AC input side. “Out-phase” refers to out-phase of three-phase power supply.

“Undervoltage” / “out-phase” signal filtering constant is used for the purpose of eliminating disturbance to avoid mis-protection. The greater the set value is, the longer the filtering time constant is and the better for the filtering effect.

F737	Software over-current protection	Setting range: 0:Invalid 1: Valid Mfr's value: 0
F738	Software over-current protection Coefficient	Setting range: 0.50~3.00 Mfr's value: 2.0
F739	Software over-current protection record	

Software over-current protection Coefficient equals to the ratio of software over-current value with inverter rated current. In running status, F738 can not be changed. When over current occurred, OC1 is displayed.

5.9 Parameters of the Motor

F800	Motor's parameters selection	Setting range: 0: no parameter measurement; 1: Stator resistance parameter measurement;	Mfr's value: 0
F801	Rated power	Setting range: 0.2~1000KW	
F802	Rated voltage	Setting range: 1~440V	
F803	Rated current	Setting range: 0.1~6553A	
F804	Number of motor poles	Setting range: 2~100	4
F805	Rated rotary speed	Setting range: 1~30000	
F810	Motor rated frequency	Setting range: 1.0~650.0Hz	50.00

Please set the parameters in accordance with those indicated on the nameplate of the motor.

Excellent control performance of vector control requires accurate parameters of the motor. Accurate parameter derives from correct setting of rated parameters of the motor.

F800=0, no parameter measurement. Please set the parameters F801~F805 and F810 correctly according to those indicated on the nameplate of the motor.

After being powered on, it will use default stator resistance parameters of the motor (see the values of F806) according to the motor power set in F801.

F800=1, stator resistance parameter measurement.

In order to ensure dynamic control performance of the inverter, please set F801-805 and F810 correctly prior to stator resistance parameters testing.

Press the "Run" key on the keypad to display "TEST". After self-checking is completed, relevant parameters of the motor will be stored in function code F806, and F800 will turn to 0 automatically.

***Note:** In order to test motor stator resistance parameters correctly, please set the information of the motor (F801-F805 and F810) correctly according to the nameplate of the motor.

F806	Stator resistance	Setting range: 0.001~65.00Ω	
------	-------------------	-----------------------------	--

The set value of F806 will be updated automatically after normal completion of stator resistance parameter measurement of the motor.

The inverter will restore the parameter value of F806 automatically to default standard parameters of the motor each time after changing F801 rated power of the motor;

If it is impossible to measure the motor at the site, input the parameters manually by referring to the known parameters of a similar motor.

5.10 Communication Parameter

F900	Communication Address	1~255: single inverter address 0: broadcast address	1
F901	Communication Mode	1: ASCII 2: RTU 3: Remote controlling keypad (Only for inverter power below 15KW)	1
F903	Odd/Even Calibration	Setting range: 0: no calibration 1: odd calibration 2: even calibration	0
F904	Baud Rate	Setting range: 0: 1200; 1: 2400; 2: 4800; 3: 9600; 4: 19200 5: 38400 6: 57600	3

Please set F901 to 3 to select remote controlling keypad, the keypad of inverter will automatically close

for saving energy.

If the keypad of inverter and remote controlling keypad need work at the same time, please connect OP5 terminal to CM terminal. When inverter works steadily, please disconnect OP5 with CM in case malfunction. F904~9600 is recommended for baud rate, which makes run steady. Communication parameters refer to Appendix 4.

5.11 PID Parameters

When F203 or F204 selects PID adjusting, this group function is valid.

FA00 Polarity	0: positive feedback 1: negative feedback	0
---------------	---	---

Positive feedback: when feedback signal is higher than PID setting, output frequency will increase automatically to balance PID adjusting.

Negative feedback: when feedback signal is higher than PID setting, output frequency will decrease automatically to balance PID adjusting.

FA01 Reference source	Setting range: 0: Given digital; 1: AI1; 2: AI2; 3: Input pulse given; 4-5: Reserved;	0
-----------------------	--	---

The given channel of reference source is set by FA01.

When FA01=0, digital reference source is set by FA02.

FA02 Given Digit Reference Source	0.0~100.0	50.0
-----------------------------------	-----------	------

When FA01=0, reference source is controlled by keypad. This parameter should be set.

The setting value of FA02 is the relative value, it's benchmark value is max feedback value of the system.

FA03 Feedback Source	0: AI1 1: AI2 2: Input pulse frequency; 4~5: Reserved	0
----------------------	---	---

PID feedback channel is set by FA03.

FA04 Proportion Coefficient	0.0~100.0	20.0
FA05 Integral Time	0.1~10.0S	2.0
FA06 Precision	0.0~20.0	0.1
FA07 Show Value of Min Feedback	0~9999	0
FA08 Show Value of Max Feedback	0~9999	1000

Dormancy function

FA10 Dormancy function selection	Setting range: 0: Invalid 1: Valid	0
FA11 Dormancy waking value	Setting range: 0~100 (%)	10
FA12 Feedback limit value	Setting range: 0~100 (%)	80
FA13 Dormancy delay time	Setting range: 0~300.0 (S)	60.0S
FA14 Wake delay time	Setting range: 0~300.0 (S)	60.0S

Dormancy function is an energy saving mode when PID mode is selected (F203=9). When FA10=1, if inverter runs at the min frequency for a period time set by FA13, inverter will output 0Hz to save energy, and run lamp twinkles. After inverter is awakened, PID adjusting will go on.

Dormancy waking value is the percentage of max value of feedback channel. For example: AN2 channel is feedback channel, which input voltage range is 0~10V, when FA11=10, then waking value is $10V \times 10\% = 1V$. When feedback value is lower than FA11 (negative feedback) or higher than FA11 (positive feedback), inverter is awakened and PID adjusting will go on.

Feedback limit value is the percentage of max value of feedback channel. When feedback value is higher than (negative feedback) or lower than (positive feedback) the setting value of FA12, inverter will immediately free stop.

Delay time before dormancy is set by FA13. Delay time before wake up is set by FA14.

Appendix 1 Trouble Shooting

When malfunction occurs to inverter, don't run by resetting immediately. Check any causes and get it removed if there is any.

Take counter measures by referring to this manual in case of any malfunctions on inverter. Should it still be unsolved, contact the manufacturer. Never attempt any repairing without due authorization.

Table 1-1 Inverter's Common Cases of Malfunctions

Fault	Description	Causes	Countermeasures
O.C.	Hardware Overcurrent	* too short acceleration time * short circuit at output side	*prolong acceleration time; *whether motor cable is broken;
OC1	Software Overcurrent	* locked rotor with motor	*check if motor overloads; *reduce V/F compensation value
O.L1	Inverter Overload	* load too heavy	*reduce load; *check drive ratio; *increase inverter's capacity
O.L2	Motor Overload	* load too heavy	*reduce load; *check drive ratio; *increase inverter's capacity
O.E.	DC Over-Voltage	*supply voltage too high; *load inertia too big *deceleration time too short; *motor inertia rise again	*check if rated voltage is input; *add braking resistance(optional); *increase deceleration time
P.F1.	Input Out-Phase	*out-phase with input power	*check if power input is normal; *check if parameter setting is correct.
PF0	Output Out-phase	* Motor is broken	* check if wire of motor is loosen. * check if motor is broken.
L.U.	Under-Voltage Protection	*input voltage on the low side	*check if supply voltage is normal *check if parameter setting is correct.
O.H.	Radiator Overheat	*environment temperature too high; *radiator too dirty *install place not good for ventilation; *fan damaged	*improve ventilation; *clean air inlet and outlet and radiator; *install as required; *change fan
ERR1	Password is wrong	*When password function is valid, password is set wrong.	*please set password correctly.
ERR2	Measurement parameters wrong	* Do not connect motor when measuring parameters	*please connect motor correctly.
ERR3	Current malfunction before running	*Current alarm signal exists before running.	*check if control board is connected with power board well. *ask for help from manufacture.
ERR4	Current zero excursion malfunction	*Flat cable is loosened. *Current detector is broken.	*check the flat cable. *ask for help from manufacture.

- No P.F1. protection for single-phase and three-phase under 4.0KW.

Table 1-2 **Motor Malfunction and Counter Measures**

Malfunction	Items to Be Checked	Counter Measures
Motor not Running	Wiring correct? Setting correct? Too big with load? Motor is damaged? Malfunction protection occurs?	Get connected with power; Check wiring; Checking malfunction; Reduce load; Check against Table 1-1
Wrong Direction of Motor Running	U, V, W wiring correct? Parameters setting correct?	To correct wiring Setting the parameters correctly.
Motor Turning but Speed Change not Possible	Wiring correct for lines with given frequency? Correct setting of running mode? Too big with load?	To correct wiring; To correct setting; Reduce load
Motor Speed Too High or Too Low	Motor's rated value correct? Drive ratio correct? Inverter parameters are set incorrectly? Check if inverter output voltage is abnormal?	Check motor nameplate data; Check the setting of drive ratio; Check parameters setting; Check V/F Characteristic value
Motor Running Unstable	Too big load? Too big with load change? Out-phase? Motor malfunction.	Reduce load; reduce load change, increase capacity; Correct wiring.
Power Trip	Wiring current is too high?	Check input wiring; Selecting matching air switch; Reduce load; checking inverter malfunction.

Appendix 2 **Products & Structures**

E1000 series inverter has its power range between 0.2~630KW. Refer to Tables 2-1 and 2-2 for main data. There may be two (or more than two) kinds of structures for certain products. Please make a clear indication when placing your order.

Inverter should operate under the rated output current, with overload permitted for a short time. However, it shall not exceed the allowable values at working time.

Table 2-1 **Product Summary of E1000**

Model	Applicable Motor (kw)	Rated Current Output (A)	Structure Code	Cooling Mode	Weight (kg)	Remarks
E1000-0002S2	0.2	1.5	E1	Self-cooling	1.36	Single-Phase Plastic Hanging
E1000-0004S2	0.4	2.5	E1	Air-cooling	1.4	
E1000-0007S2	0.75	4.5	E1	Air Cooling	1.43	
E1000-0015S2	1.5	7	E2	Air Cooling	2.0	
E1000-0022S2	2.2	10	E3	Air Cooling	2.28	
E1000-0007T3	0.75	2	E2	Air Cooling	2.0	Three-Phase Plastic Hanging
E1000-0015T3	1.5	4	E2	Air Cooling	2.0	
E1000-0022T3	2.2	6.5	E2	Air Cooling	2.0	
E1000-0037T3	3.7	8	E4	Air Cooling	3.02	
E1000-0040T3	4.0	9	E4	Air Cooling	3.02	
E1000-0055T3	5.5	12	E5	Air Cooling	4.2	
E1000-0075T3	7.5	17	E5	Air Cooling	4.4	
E1000-0110T3	11	23	E6	Air Cooling	8.0	
E1000-0150T3	15	32	E6	Air Cooling	8.2	

E1000-0185T3	18,5	38	C3	Air Cooling	19	Three-phase Metal hanging (Without built-in filter)
E1000-0220T3	22	44	C3	Air Cooling	20	
E1000-0300T3	30	60	C3	Air Cooling	22.5	
E1000-0370T3	37	75	C5	Air Cooling	37.6	
E1000-0450T3	45	90	C5	Air Cooling	38.6	
E1000-0550T3	55	110	C5	Air Cooling	41.5	
E1000-0750T3	75	150	C6	Air Cooling	55	
E1000-0900T3	90	180	C6	Air Cooling	56	
E1000-1100T3	110	220	C7	Air Cooling	87	
E1000-1320T3	132	265	C8	Air Cooling	120	
E1000-1600T3	160	320	C8	Air Cooling	123	
E1000-1800T3	180	360	C9	Air Cooling	125	
E1000-2000T3	200	400	CA	Air Cooling	180	
E1000-2200T3	220	440	CA	Air Cooling	185	
E1000-2500T3	250	480	CB	Air Cooling	220	
E1000-2800T3	280	530	CB	Air Cooling	225	
E1000-3150T3	315	580	CB	Air Cooling	230	
E1000-3550T3	355	640	CB	Air Cooling	233	
E1000-1100T3D	110	220	D0	Air Cooling	160	Three-phase Metal cabinet (Without built-in filter)
E1000-1320T3D	132	265	D1	Air Cooling	200	
E1000-1600T3D	160	320	D1	Air Cooling	202	
E1000-1800T3D	180	360	D1	Air Cooling	205	
E1000-2000T3D	200	400	D2	Air Cooling	275	
E1000-2200T3D	220	440	D2	Air Cooling	280	
E1000-2500T3D	250	480	D3	Air Cooling	350	
E1000-2800T3D	280	530	D3	Air Cooling	380	
E1000-3150T3D	315	580	D3	Air Cooling	385	
E1000-3550T3D	355	640	D3	Air Cooling	445	
E1000-4000T3D	400	690	D4	Air Cooling	535	
E1000-4500T3D	450	770	D5	Air Cooling	670	
E1000-5000T3D	500	860	D5	Air Cooling	675	
E1000-5600T3D	560	950	D5	Air Cooling	700	
E1000-6300T3D	630	1100	D5	Air Cooling	700	
E1000-0185T3R	18,5	38	E7	Air Cooling	24.5	Three-phase Metal hanging (With built-in filter)
E1000-0220T3R	22	44	E7	Air Cooling	25.5	
E1000-0300T3R	30	60	E7	Air Cooling	28	
E1000-0370T3R	37	75	E8	Air Cooling	48	
E1000-0450T3R	45	90	E8	Air Cooling	49	
E1000-0550T3R	55	110	E8	Air Cooling	52	
E1000-0750T3R	75	150	E9	Air Cooling	66,5	
E1000-0900T3R	90	180	E9	Air Cooling	67.5	

Table 2-2 E1000 Types of Product Structure

Structure Code	External Dimension [A×B(B1)×H] ^{note1}	Mounting Size(W×L)	Mounting Bolt	Remarks
E1	80×135 (142) ×138	70×128	M4	Plastic Housing
E2	106×150 (157) ×180	94×170	M4	
E3	106×170 (177) ×180	94×170	M4	
E4	138×152 (159) ×235	126×225	M5	
E5	156×170 (177) ×265	146×255	M5	
E6	205×196(202)×340	194×330	M5	
E7	271×235×637	235×613	M6	Metal Housing
E8	360×265×901	320×876	M8	
E9	420×300×978	370×948	M10	
C3	265×235×435	235×412	M6	
C5	360×265×555	320×530	M8	
C6	410×300×630	370×600	M10	
C7	516×326×760	360×735	M12	
C8	560×326×1000	390×970	M12	
C9	400×385×1300	280×1272	M10	
CA	535×380×1330	470×1300	M10	
CB	600×380×1580	545×1550	M10	Metal Cabinet
D0	580×500×1410	410×300	M16	
D1	600×500×1650	400×300	M16	
D2	660×500×1850	450×300	M16	
D3	800×600×1950	520×340	M16	
D4	1000×550×2000	800×350	M16	
D5	1200×600×2200	986×400	M16	

Note 1: the unit is mm.

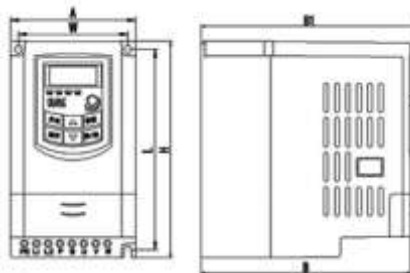

Plastic Profile

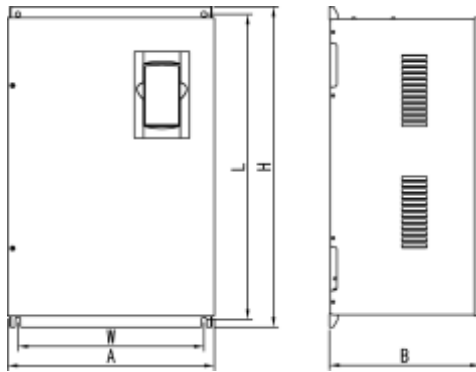

Metal Hanging Profile

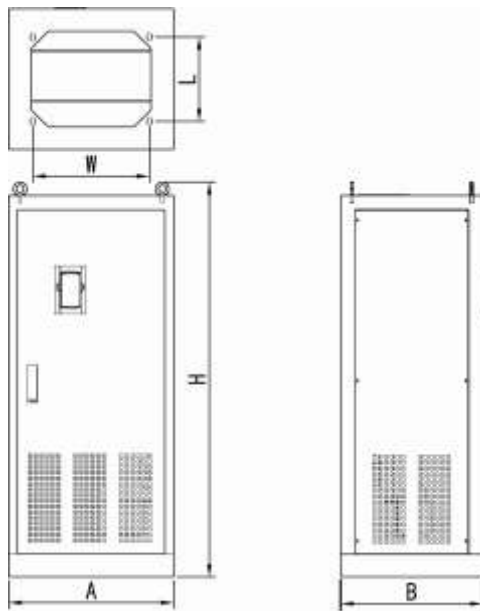

Metal Cabinet Profile

Appendix 3 Selection of Braking Resistance

Inverter Models	Applicable Motor Power (KW)	Applicable Braking Resistance
E1000-0002S2	0.2	150W/60Ω
E1000-0004S2	0.4	
E1000-0007S2	0.75	
E1000-0015S2	1.5	
E1000-0022S2	2.2	
E1000-0007T3	0.75	80W/200Ω
E1000-0015T3	1.5	80W/150Ω
E1000-0022T3	2.2	150W/150Ω
E1000-0037T3	3.7	
E1000-0040T3	4.0	
E1000-0055T3	5.5	250W/120Ω
E1000-0075T3	7.5	500W/120Ω
E1000-0110T3C	11	1KW/90Ω
E1000-0150T3C	15	1.5KW/80Ω

Appendix 4 Communication Manual

(Version 1.8)

I. General

Modbus is a serial and asynchronous communication protocol. Modbus protocol is a general language applied to PLC and other controlling units. This protocol has defined an information structure which can be identified and used by a controlling unit regardless of whatever network they are transmitted.

You can read reference books or ask for the details of MODBUS from manufactures.

Modbus protocol does not require a special interface while a typical physical interface is RS485.

II. Modbus Protocol

2.1 Transmission mode

2.1.1 Format

1) ASCII mode

Start	Address	Function	Data				LRC check		End	
: (0X3A)	Inverter Address	Function Code	Data Length	Data 1	...	Data N	High-order byte of LRC	Low-order byte of LRC	Return (0X0D)	Line Feed (0X0A)

2) RTU mode

Start	Address	Function	Data	CRC check		End
T1-T2-T3-T4	Inverter Address	Function Code	N data	Low-order byte of CRC	High-order byte of CRC	T1-T2-T3-T4

2.1.2 ASCII Mode

In ASCII mode, one Byte (hexadecimal format) is expressed by two ASCII characters.

For example, 31H (hexadecimal data) includes two ASCII characters '3(33H)', '1(31H)'.

Common characters, ASCII characters are shown in the following table:

Characters	'0'	'1'	'2'	'3'	'4'	'5'	'6'	'7'
ASCII Code	30H	31H	32H	33H	34H	35H	36H	37H
Characters	'8'	'9'	'A'	'B'	'C'	'D'	'E'	'F'
ASCII Code	38H	39H	41H	42H	43H	44H	45H	46H

2.1.3 RTU Mode

In RTU mode, one Byte is expressed by hexadecimal format. For example, 31H is delivered to data packet.

2.2 Baud rate

Setting range: 1200, 2400, 4800, 9600, 19200, 38400, 57600

2.3 Frame structure:

ASCII mode

Byte	Function
1	Start Bit (Low Level)

7	Data Bit
0/1	Parity Check Bit (None for this bit in case of no checking. Otherwise 1 bit)
1/2	Stop Bit (1 bit in case of checking, otherwise 2 bits)

2) RTU mode

Byte	Function
1	Start Bit (Low Level)
8	Data Bit
0/1	Parity Check Bit (None for this bit in case of no checking. Otherwise 1 bit)
1/2	Stop Bit (1 bit in case of checking, otherwise 2 bits)

2.4 Error Check

2.4.1 ASCII mode

Longitudinal Redundancy Check (LRC): It is performed on the ASCII message field contents excluding the ‘colon’ character that begins the message, and excluding the CRLF pair at the end of the message.

The LRC is calculated by adding together successive 8-bit bytes of the message, discarding any carries, and then two’s complementing the result.

A procedure for generating an LRC is:

1. Add all bytes in the message, excluding the starting ‘colon’ and ending CRLF. Add them into an 8-bit field, so that carries will be discarded.
2. Subtract the final field value from FF hex (all 1’s), to produce the ones-complement.
3. Add 1 to produce the twos-complement.

2.4.2 RTU Mode

Cyclical Redundancy Check (CRC): The CRC field is two bytes, containing a 16-bit binary value.

The CRC is started by first preloading a 16-bit register to all 1’s. Then a process begins of applying successive 8-bit bytes of the message to the current contents of the register. Only the eight bits of data in each character are used for generating the CRC. Start and stop bits, and the parity bit, do not apply to the CRC.

A procedure for generating a CRC-16 is:

1. Load a 16-bit register with FFFF hex (all 1’s). Call this the CRC register.
2. Exclusive OR the first 8-bit byte of the message with the high-order byte of the 16-bit CRC register, putting the result in the CRC register.
3. Shift the CRC register one bit to the right (toward the LSB), zero-filling the MSB. Extract and examine the LSB.
4. (If the LSB was 0): Repeat Step 3 (another shift).

(If the LSB was 1): Exclusive OR the CRC register with the polynomial value A001 hex (1010 0000 0000 0001).

5. Repeat Steps 3 and 4 until 8 shifts have been performed. When this is done, a complete 8-bit byte will have been processed.

When the CRC is appended to the message, the low-order byte is appended first, followed by the high-order byte.

2.4.3 Protocol Converter

It is easy to turn a RTU command into an ASCII command followed by the lists:

- 1) Use the LRC replacing the CRC.
- 2) Transform each byte in RTU command into a corresponding two byte ASCII. For example: transform 0x03 into 0x30, 0x33 (ASCII code for 0 and ASCII code for 3).
- 3) Add a 'colon' (:) character (ASCII 3A hex) at the beginning of the message.
- 4) End with a 'carriage return – line feed' (CRLF) pair (ASCII 0D and 0A hex).

So we will introduce RTU Mode in followed part. If you use ASCII mode, you can use the up lists to convert.

2.5 Command Type & Format

2.5.1 The listing below shows the function codes.

code	name	description
03	Read Holding Registers	Read the binary contents of holding registers in the slave. (Less than 10 registers once time)
06	Preset Single Register	Preset a value into holding register

2.5.2 Address and meaning

The part introduces inverter running, inverter status and related parameters setting.

Description of rules of function codes parameters address:

- 1) Use the function code as parameter address

General Series:

High-order byte: 01~0A (hexadecimal)

Low-order byte: 00~50 (max range) (hexadecimal) Function code range of each partition is not the same. The specific range refers to manual.

For example: F114 (display on the board), parameter address is 010E (hexadecimal).

F201 (display on the board), parameter address is 0201 (hexadecimal).

Note: in this situation, it allows to read six function codes and write only one function code.

Some function codes can only be checked but cannot be modified; some function codes can neither be checked nor be modified; some function codes can not be modified in run state; some function codes can not be modified both in stop and run state.

In case parameters of all function codes are changed, the effective range, unit and related instructions shall refer to user manual of related series of inverters. Otherwise, unexpected results may occur.

- 2) Use different parameters as parameter address

(The above address and parameters descriptions are in hexadecimal format, for example, the decimal digit 4096 is represented by hexadecimal 1000).

1. Running status parameters

Parameters Address	Parameter Description (read only)
1000	Output frequency
1001	Output voltage
1002	Output current
1003	Pole numbers/ control mode, high-order byte is pole numbers, low-order byte is control mode.
1004	Bus-line voltage
1005 ---E1000	Drive ratio/inverter status High-order byte is drive ratio, low-order byte is inverter status Inverter status: 00: Standby mode 01: Forward running 02: Reverse running 04: Over-current (OC) 05: DC over-current (OE) 06: Input Out-phase (PF1) 07: Frequency Over-load (OL1) 08: Under-voltage (LU) 09: Overheat (OH) 0A: Motor overload (OL2) 0B: Interference (ERR) 0C: LL 0D: External Malfunction (ESP) 0E: ERR1 0F: ERR2 10: ERR3 11: ERR4

2. Control commands

Parameters Address	Parameters Description (write only)
2000 ^{note1}	Command meaning: 0001: Forward running (no parameters) 0002: Reverse running (no parameters) 0003: Deceleration stop 0004: Free stop 0005: Forward jogging start 0006: Forward jogging stop 0007: Reserved 0008: Run (no directions) 0009: Fault reset 000A: Forward jogging stop 000B: Reverse jogging stop
2001	Lock parameters 0001: Relieve system locked (remote control locked) 0002: Lock remote control (any remote control commands are no valid before unlocking)

Note 1: Command types of 2000 do not belong to every inverter models.

2. Illegal Response When Reading Parameters

Command Description	Function	Data
Slave parameters response	The highest-order byte changes into 1.	Command meaning: 0001: Illegal function code 0002: Illegal address 0003: Illegal data 0004: Slave fault ^{note 2}

Note 2: Illegal response 0004 appears below two cases:

1. Do not reset inverter when inverter is in the malfunction state.
2. Do not unlock inverter when inverter is in the locked state.

2.5.3 Additional Remarks

Expressions during communication course:

Parameter Values of Frequency=actual value X 100 (General Series)
 Parameter Values of Frequency=actual value X 10 (Medium Frequency Series)
 Parameter Values of Time=actual value X 10
 Parameter Values of Current=actual value X 10
 Parameter Values of Voltage=actual value X 1
 Parameter Values of Power=actual value X 100
 Parameter Values of Drive Ratio=actual value X 100
 Parameter Values of Version No. =actual value X 100

Instruction: Parameter value is the value sent in the data package. Actual value is the actual value of inverter. After PC/PLC receives the parameter value, it will divide the corresponding coefficient to get the actual value.

NOTE: Take no account of radix point of the data in the data package when PC/PLC transmits command to inverter. The valid value is range from 0 to 65535.

III Function Codes Related to Communication

Function Code	Function Definition	Setting Rang	Mfr's Value
F200	Source of start command	0: Keypad command; 1: Terminal command; 2: Keypad+Terminal; 3:MODBUS; 4: Keypad+Terminal+MODBUS	0
F201	Source of stop command	0: Keypad command; 1: Terminal command; 2: Keypad+Terminal; 3:MODBUS; 4: Keypad+Terminal+MODBUS	0
F203	Main frequency source X	0: Digital setting memory; 1: External analog AI1; 2: External analog AI2; 3: Pulse input given; 4: Stage speed control; 5: No memory by digital setting; 6:Keypad potentiometer; 7~8: Reserved; 9: PID adjusting 10: MODBUS	0
F900	Inverter Address	1~255	1

F901	Modbus Mode Selection	1: ASCII mode 2: RTU mode 3: Remote controlling keypad (Only for inverter power below 15KW)	1
F903	Parity Check Selection	0: No checkout 1: Odd 2: Even	0
F904	Baud Rate	0: 1200 1: 2400 2: 4800 3: 9600 4: 19200 5: 38400 6: 57600	3

Please set functions code related to communication consonant with the PLC/PC communication parameters, when inverter communicates with PLC/PC.

IV Physical Interface

4.1 Interface instruction

Communication interface of RS485 is located on the most left of control terminals, marked underneath with A+ and B-

4.2 Structure of Field Bus

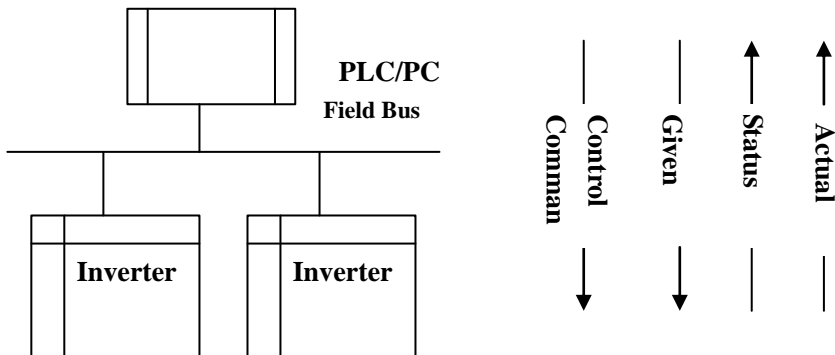

Connecting Diagram of Field Bus

RS485 Half-duplex communication mode is adopted for E2000 series inverter. Daisy chain structure is adopted by 485 Bus-line. Do not use 'spur' lines or a star configuration. Reflect signals which are produced by spur lines or star configuration will interfere in 485 communications.

Please note that for the same time in half-duplex connection, only one inverter can have communication with PC/PLC. Should two or more than two inverters upload data at the same time, then bus competition will occur, which will not only lead to communication failure, but higher current to certain elements as well.

3. Grounding and Terminal

Terminal resistance of 120 Ω will be adopted for terminal of RS485 network, to diminish the reflection of signals. Terminal resistance shall not be used for intermediate network.

No direct grounding shall be allowed for any point of RS485 network. All the equipment in the network shall be well grounded via their own grounding terminal. Please note that grounding wires will not form closed loop in any case.

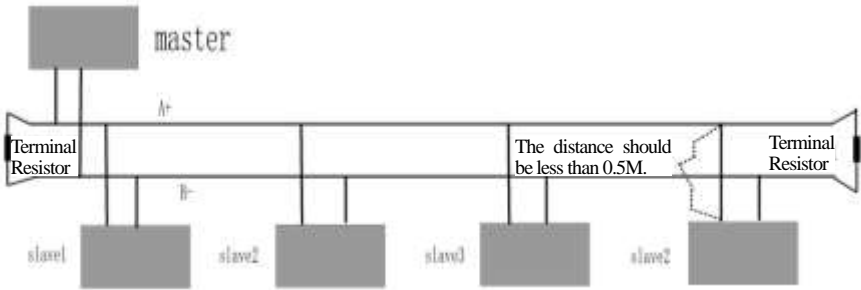

Connecting Diagram of Terminal Resistance

Please think over the drive capacity of PC/PLC and the distance between PC/PLC and inverter when wiring. Add a repeaters if drive capacity is not enough.



All wiring connections for installation shall have to be made when the inverter is disconnected from power supply.

V. Examples

Eg1: In RTU mode, change acc time (F114) to 10.0s in NO.01 inverter.

Query

Address	Function	Register Address Hi	Register Address Lo	Preset Data Hi	Preset Data Lo	CRC Lo	CRC Hi
01	06	01	0E	00	64	E8	1E

Function code F114 Value: 10.0S

Normal Response

Address	Function	Register Address Hi	Register Address Lo	Response Data Hi	Response Data Lo	CRC Lo	CRC Hi
01	06	01	0E	00	64	E8	1E

Function code F114 Normal Response

Abnormal Response

Address	Function	Abnormal code	CRC Lo	CRC Hi
01	86	04	43	A3

The max value of function code is 1. Slave fault

Eg 2: Read output frequency, output voltage, output current and current rotate speed from N0.2 inverter.

Host Query

Address	Function	First Register Address Hi	First Register Address Lo	Register count Hi	Register count L0	CRC Lo	CRC Hi
02	03	10	00	00	04	40	FA

Communication Parameters Address 1000H

Slave Response :

Address	Function	Byte Count	Data Hi	Data Lo	Data Hi	Data Lo	Data Hi	Data Lo	Data Hi	Data Lo	Crc Lo	Crc Hi
02	03	08	13	88	01	90	00	3C	02	00	82	F6

Output Frequency Output Voltage Output Current Numbers of Pole Pairs Control Mode

NO.2 Inverter's output frequency is 50.00Hz, output voltage is 400V, output current is 6.0A, numbers of pole pairs are 2 and control mode keypad control.

Eg 3: NO.1 Inverter runs forwardly.

Host Query:

Address	Function	Register Hi	Register Lo	Write status Hi	Write status Lo	CRC Lo	CRC Hi
01	06	20	00	00	01	43	CA

Communication parameters address 2000H

Forward running

Slave Normal Response:

Address	Function	Register Hi	Register Lo	Write status Hi	Write status Lo	CRC Lo	CRC Hi
01	06	20	00	00	01	43	CA

Normal Response

Slave Abnormal Response:

Address	Function	Abnormal Code	CRC Lo	CRC Hi
01	86	01	83	A0

The max value of function code is 1. Illegal function code (assumption)

Eg4: Read the value of F113, F114 from NO.2 inverter

Host Query :

Address	Function	Register Address Hi	Register Address Lo	Register Count Hi	Register Count L0	CRC Lo	CRC Hi
02	03	01	0D	00	02	54	07

Communication Parameter Address F10DH

Numbers of Read Registers

Slave Normal Response:

Address	Function	Byte count	The first parameters status Hi	The first parameters status Lo	The second parameters status Hi	The second parameters status Lo	CRC Lo	CRC Hi
02	03	04	03	E8	00	78	49	61

The actual value is 10.00.

The actual value is 12.00.

Slave Abnormal Response:

Address	Function Code	Abnormal Code	CRC Lo	CRC Hi
02	83	08	B0	F6

The max value of function code is 1.

Parity check fault

Appendix 5 Zoom Table of Function Code

Function Section	Function Code	Function Definition	Setting Range	Mfr's Value	Change
Basic Parameters	F100	User's Password	0~9999	8	√
	F102	Inverter's Rated Current (A)	1.0~800.0	Subject to inverter model	*
	F103	Inverter Power (KW)	0.20~650.0	Subject to inverter model	*
	F104	Inverter Power Code	100~400	Subject to inverter model	*
	F105	Software Edition No.	1.00~10.00	Subject to inverter model	*
	F107	Password Valid or Not	0: invalid; 1: valid	0	√
	F108	Setting User's Password	0~9999	8	√
	F109	Starting Frequency (Hz)	0.0~10.00Hz	0.00Hz	√
	F110	Holding Time of Starting Frequency (S)	0.0~10.0S	0.0	√
	F111	Max Frequency (Hz)v	F113~650.0Hz	50.00Hz	√
	F112	Min Frequency (Hz)	0.00Hz~F113	0.50Hz	√
	F113	Target Frequency (Hz)	F111~F112	50.00Hz	√
	F114	1 st Acceleration Time	0.1~3000S	5.0S for 0.2~3.7KW 30.0S for 5.5~30KW 60.0S for above 37KW.	√
	F115	1 st Deceleration Time	0.1~3000S		√
	F116	2 nd Acceleration Time	0.1~3000S	8.0S for 0.2~3.7KW 50.0S for 5.5~30KW 90.0S for above 37KW.	√
	F117	2 nd Deceleration Time	0.1~3000S		√
	F118	Turnover Frequency	15.00~650.0Hz	50.00	×
	F119	Reference of setting accel/decel time	0: 0~50.00Hz 1: 0~max frequency	0	×
	F120	Forward/Reverse Switchover dead-Time	0.0~3000S	0.0S	√
	F121	Reserved			
	F122	Reverse Running Forbidden	0: invalid; 1: valid	0	×
	F123	Minus frequency is valid in the mode of combined speed control.	0: Invalid; 1: valid	0	×
	F124	Jogging Frequency	F112~F111	5.00Hz	√
	F125	Jogging Acceleration Time	0.1~3000S	0.2~3.7KW: 5.0S 5.5~30KW: 30.0S	√
	F126	Jogging Deceleration Time	0.1~3000S	Above37KW: 60.0S	√

Basic Parameters	F127	Skip Frequency A	0.00~650.0Hz	0.00Hz	√
	F128	Skip Width A	±2.50Hz	0.00	√
	F129	Skip Frequency B	0.00~650.0Hz	0.00Hz	√
	F130	Skip Width B	±2.50Hz	0.00	√
	F131	Running Display Items	0—Present output frequency / function code 1—Current output rotary speed 2—Output current 4—Output voltage 8—PN voltage 16—PID feedback value 32—Temperature 64—Count values 128—Linear speed	0+1+2+4+8=15	√
	F132	Display items of stop	0: frequency / function code 1: Keypad jogging 2: Target rotary speed 4: PN voltage 8: PID feedback value 16: Temperature 32: Count values	2+4=6	√
	F133	Drive Ratio of Driven System	0.10~200.0	1.0	√
	F134	Transmission-wheel radius	0.001~1.000 (m)	0.001	√
	F135	Reserved			
	F136	Slip compensation	0~10%	0	×
	F137	Modes of torque compensation	0: Linear compensation; 1: Square compensation; 2: User-defined multipoint compensation 3: Auto torque compensation	3	×
	F138	Linear compensation	1~16	0.2-3.7: 5 5.5-30: 4 Above 37: 3	×
	F139	Square compensation	1: 1.5; 2: 1.8; 3: 1.9; 4: 2.0	1	×
	F140	User-defined frequency point 1	0~F142	1.00	×
	F141	User-defined voltage point 1	0~100%	4	×
F142	User-defined frequency point 2	F140~F144	5.00	×	
F143	User-defined voltage point 2	0~100%	13	×	

Basic Parameters	F144	User-defined frequency point 3	F142~F146	10.00	×
	F145	User-defined voltage point 3	0~100%	24	×
	F146	User-defined frequency point 4	F144~F148	20.00	×
	F147	User-defined voltage point 4	0~100%	45	×
	F148	User-defined frequency point 5	F146~F150	30.00	×
	F149	User-defined voltage point 5	0~100%	63	×
	F150	User-defined frequency point 6	F148~F118	40.00	×
	F151	User-defined voltage point 6	0~100%	81	×
	F152	Output voltage corresponding to turnover frequency	10~100%	100	×
	F153	Carrier frequency setting	0.2~7.5KW: 2~10K	4K	×
			11~15KW: 2~10K	3K	
			18.5KW~45KW: 2~6K	4K	
			Above 55KW: 2~4K	2K	
	F154	Automatic voltage rectification	0: Invalid 1: Valid 2:Invalid during deceleration process	0	×
	F155	Digital accessory frequency setting	0~F111	0	×
	F156	Digital accessory frequency polarity setting	0 or 1	0	×
F157	Reading accessory frequency			△	
F158	Reading accessory frequency polarity			△	
F159	Random carrier-wave frequency selection	0: Control speed normally; 1: Random carrier-wave frequency	1		
F160	Reverting to manufacturer values	0: Not reverting to manufacturer values; 1: Reverting to manufacturer values	0	×	
Running Control Mode	F200	Source of start command	0: Keypad command; 1: Terminal command; 2: Keypad + Terminal; 3:MODBUS; 4: Keypad + Terminal + MODBUS	0	×
	F201	Source of stop command	0: Keypad command; 1: Terminal command; 2: Keypad + Terminal; 3:MODBUS; 4: Keypad + Terminal + MODBUS	0	×
	F202	Mode of direction setting	0: Forward running locking; 1: Reverse running locking; 2: Terminal setting	0	×

Running Control Mode

F203	Main frequency source X	0: Digital setting memory; 1: External analog AI1; 2: External analog AI2; 3: Pulse input given; 4: Stage speed control; 5: No memory by digital setting; 6: Keypad potentiometer; 7-8: Reserved; 9: PID adjusting; 10: MODBUS	0	×
F204	Accessorial frequency source Y	0: Digital setting memory; 1: External analog AI1; 2: External analog AI2; 3: Pulse input given; 4: Stage speed control; 5: PID adjusting; 6: Keypad potentiometer AI3	0	×
F205	Reference for selecting accessorial frequency source Y range	0: Relative to max frequency; 1: Relative to frequency X	0	×
F206	Accessorial frequency Y range	0~100%	100	×
F207	Frequency source selecting	0: X; 1: X+Y; 2: X or Y (terminal switchover); 3: X or X+Y (terminal switchover); 4: Combination of stage speed and analog 5: X-Y 6: X+(Y-50%)	0	×
F208	Terminal two-line/three-line operation control	0: other type; 1: two-line type 1; 2: two-line type 2; 3: three-line operation control 1; 4: three-line operation control 2; 5: start/stop controlled by direction pulse	0	×
F209	Selecting the mode of stopping the motor	0: stop by deceleration time; 1: free stop	0	×
F210	Frequency display accuracy	0.01~2.00	0.01	√
F211	Speed of digital speed control	0.01~100.00Hz/S	5.00 Hz/S	√
F212	Direction memory	0: Invalid 1: Valid	0	√
F213	Selfstarting after repowered on	0: invalid; 1: valid	0	√
F214	Selfstarting after reset	0: invalid; 1: valid	0	√
F215	Selfstarting delay time	0.1~3000.0	60.0	√
F216	Times of selfstarting in case of repeated faults	0~5	0	√
F217	Delay time for fault reset	0.0~10.0	3.0	√
F218~F219	Reserved			
F220	Frequency memory after power-down	0: invalid; 1: valid	0	√
F221	Reserved			
F222	count memory selection	Setting range: 0: Invalid 1: Valid	0	√
F223~F230	Reserved			

Function Section	Function Code	Function Definition	Setting Range	Mfr's Value	Change
Multifunctional Input and Output Terminals	F300	Relay token output	0: no function; 1: inverter fault protection; 2: over latent frequency 1; 3: over latent frequency 2; 4: free stop;	1	√
	F301	DO1 token output	5: inverter running status 1; 6: DC braking; 7: acceleration/deceleration time switchover;	14	√
	F302	DO2 token output	8: Reaching the Set Count Value; 9: Reaching the Designated Count Value; 10: inverter overload pre-alarm; 11: motor overload pre-alarm; 12: stalling; 13: Inverter is ready to run 14: inverter running status 2; 15: frequency arrival output; 16: Over heat pre-alarm 17: over latent current output 18: reserved	5	
	F303	DO1 output types selection	0: level output : pulse output	0	√
	F304-F306	Reserved			
	F307	Characteristic frequency 1	F112~F111	10.00Hz	√
	F308	Characteristic frequency 2	F112~F111	50.00Hz	√
	F309	Characteristic frequency width	0~100%	50%	√
	F310	Characteristic current	0~1000A	Rated current	√
	F311	Characteristic current hysteretic loop width	0~100%	10%	√
	F312	Frequency arrival threshold	0.00~5.00Hz	0.00	√
	F313	Count frequency divisions	1~65000	1	√
	F314	Set count values	F315~65000	1000	√
	F315	Designated count values	1~F314	500	√

Multifunctional Input and Output Terminals	F316	OP1 terminal function setting	0: no function; 1: running terminal; 2: stop terminal;	11	√
	F317	OP2 terminal function setting	3: multi-stage speed terminal 1; 4: multi-stage speed terminal 2; 5: multi-stage speed terminal 3;	9	√
	F318	OP3 terminal function setting	6: multi-stage speed terminal 4; 7: reset terminal;	15	√
	F319	OP4 terminal function setting	8: free stop terminal; 9: external emergency stop terminal; 10: acceleration/deceleration	16	√
	F320	OP5 terminal function setting	forbidden terminal; 11: forward run jogging; 12: reverse run jogging;	7	√
	F321	OP6 terminal function setting	13: UP frequency increasing terminal; 14: DOWN frequency decreasing terminal; 15: "FWD" terminal;	8	√
	F322	OP7 terminal function setting	16: "REV" terminal; 17: three-line type input "X" terminal; 18: acceleration/deceleration time	1	√
	F323	OP8 terminal function setting	switchover terminal; 19-20: Reserved; 21: frequency source switchover	2	√
	F324	Free stop terminal logic	terminal; 22: Count input terminal; 23: Count reset terminal 24~30: Reserved	0	×
	F325	External emergency stop terminal logic	0: positive logic (valid for low level); 1: negative logic (valid for high level)	0	×
	F328	Terminal filter times	1~100	10	√
	F329~F330	Reserved			
	Function Section	Function Code	Function Definition	Setting Range	Mfr's Value
Analog Input and Output	F400	Lower limit of AI1 channel input	0.00~F402	0.01V	√
	F401	Corresponding setting for lower limit of AI1 input	0~F403	1.00	√
	F402	Upper limit of AI1 channel input	F400~10.00V	10.00V	√
	F403	Corresponding setting for upper limit of AI1 input	Max (1.00, F401) ~2.00	2.00	√
	F404	AI1 channel proportional gain K1	0.0~10.0	1.0	√
	F405	AI1 filtering time constant	0.01~10.00	0.10	√
	F406	Lower limit of AI2	0.00~F408	0.01V	√
	F407	Corresponding setting for lower limit of AI2 input	0~F409	1.00	√

Analog Input and Output	F408	Upper limit of AI2 channel input	F406~10.00V	10.00V	√
	F409	Corresponding setting for upper limit of AI2 input	Max (1.00, F407) ~2.00	2.00	√
	F410	AI2 channel proportional gain K2	0.0~10.0	1.0	√
	F411	AI2 filtering time constant	0.1~50.0	5.0	√
	F412	Lower limit of AI3 channel input	0.00~F414	0.05V	√
	F413	Corresponding setting for lower limit of AI3 input	0~F415	1.00	√
	F414	Upper limit of AI3 channel input	F412~10.0V	10.0V	√
	F415	Corresponding setting for upper limit of AI3 input	Max (1.00, F413) ~2.00	2.00	√
	F416	AI3 channel proportional gain K1	0.0~10.0	1.0	√
	F417	AI3 filtering time constant	0.1~50.0	5.0	√
	F418	AI1 channel 0Hz voltage dead zone	0~0.50V (Positive-Negative)	0.00	√
	F419	AI2 channel 0Hz voltage dead zone	0~0.50V	0.00	√
	F420	AI3 channel 0Hz voltage dead zone	0~0.50V	0.00	√
	F421~F422	Reserved			
	F423	AO1 output range selecting	0: 0~5V; 1: 0~10V	1	√
	F424	Corresponding frequency for lowest voltage of AO1 output	0.0~F425	0.05Hz	√
	F425	Corresponding frequency for highest voltage of AO1 output	F425~F111	50.00Hz	√
	F426	AO1 output compensation	0~120%	100	√
	F427	AO2 output range	0: 0~20mA; 1: 4~20mA	0	√
	F428	AO2 lowest corresponding frequency	0.0~F429	0.05Hz	√
	F429	AO2 highest corresponding frequency	F428~F111	50.00Hz	√
	F430	AO2 output compensation	0~120%	100	√
	F431	AO1 analog output signal selecting	0: Running frequency; 1: Output current; 2: Output voltage; 3~5: Reserved	0	√
	F432	AO2 analog output signal selecting		1	√
	F433	Corresponding current for full range of external voltmeter		0.01~5.00 times of rated current	2
	F434	Corresponding current for full range of external ammeter	2		×
	F435~F436	Reserved			
	F437	Analog filter width	1~100	10	*

Analog Input and Output	F438~F439	Reserved			
	F460	AI1 channel input mode	0: straight line mode 1: folding line mode	0	×
	F461	AI2 channel input mode	0: straight line mode 1: folding line mode	0	×
	F462	AI1 insertion point A1 voltage value	F400~F464	2.00V	×
	F463	AI1 insertion point A1 setting value	F401~F465	1.40	×
	F464	AI1 insertion point A2 voltage value	F462~F466	3.00V	×
	F465	AI1 insertion point A2 setting value	F463~F467	1.60	×
	F466	AI1 insertion point A3 voltage value	F464~F402	4.00V	×
	F467	AI1 insertion point A3 setting value	F465~F403	1.80	×
	F468	AI2 insertion point B1 voltage value	F406~F470	2.00V	×
	F469	AI2 insertion point B1 setting value	F407~F471	1.40	×
	F470	AI2 insertion point B2 voltage value	F468~F472	3.00V	×
	F471	AI2 insertion point B2 setting value	F469~F473	1.60	×
	F472	AI2 insertion point B3 voltage value	F470~F412	4.00V	×
F473	AI2 insertion point B3 setting value	F471~F413	1.80	×	
Pulse Input and Output	F440	Min frequency of input pulse FI	0.00~F442	0.00K	√
	F441	Corresponding setting of FI min frequency	0.00~F443	1.00	√
	F442	Max frequency of input pulse FI	F440~50.00K	10.00K	√
	F443	Corresponding setting of FI max frequency	Max (1.00, F441) ~2.00	2.00	√
	F444	Reserved			
	F445	Filtering constant of FI input pulse	0~100	0	√
	F446	FI channel 0Hz frequency dead zone	0~F442Hz (Positive-Negative)	0.00	√
	F447-F448	Reserved			
	F449	Max frequency of output pulse FO	0.00~50.00K	10.00K	√
	F450	Zero drift coefficient of output pulse frequency	0.0~100.0%	0.0%	√
	F451	Frequency gain of output pulse	0.00~10.00	1.00	√
F452	Reserved				

	F453	Output pulse signal	0: Running frequency 1: Output current 2: Output voltage 3~5: reserved	0	√
Function Section	Function Code	Function Definition	Setting Range	Mfr's Value	Change
Multi-stage Speed Control	F500	Stage speed type	0: 3-stage speed; 1: 15-stage speed; 2: Max 8-stage speed auto circulating	1	×
	F501	Selection of Stage Speed Under Auto-circulation Speed Control	2~8	7	√
	F502	Selection of Times of Auto-Circulation Speed Control	0~9999 (when the value is set to 0, the inverter will carry out infinite circulating)	0	√
	F503	Status after auto circulation running Finished	0: Stop 1: Keep running at last stage speed	0	√
	F504	Frequency setting for stage 1 speed	F112~F111	5.00Hz	√
	F505	Frequency setting for stage 2 speed	F112~F111	10.00Hz	√
	F506	Frequency setting for stage 3 speed	F112~F111	15.00Hz	√
	F507	Frequency setting for stage 4 speed	F112~F111	20.00Hz	√
	F508	Frequency setting for stage 5 speed	F112~F111	25.00Hz	√
	F509	Frequency setting for stage 6 speed	F112~F111	30.00Hz	√
	F510	Frequency setting for stage 7 speed	F112~F111	35.00Hz	√
	F511	Frequency setting for stage 8 speed	F112~F111	40.00Hz	√
	F512	Frequency setting for stage 9 speed	F112~F111	5.00Hz	√
	F513	Frequency setting for stage 10 speed	F112~F111	10.00Hz	√
	F514	Frequency setting for stage 11 speed	F112~F111	15.00Hz	√
	F515	Frequency setting for stage 12 speed	F112~F111	20.00Hz	√
	F516	Frequency setting for stage 13 speed	F112~F111	25.00Hz	√
	F517	Frequency setting for stage 14 speed	F112~F111	30.00Hz	√
F518	Frequency setting for stage 15 speed	F112~F111	35.00Hz	√	

	F519~F533	Acceleration time setting for the speeds from Stage 1 to stage 15	0.1~3000S	0.2~3.7KW:5.0S; 5.5~30KW:30.0S; Above 37KW: 60.0S	√
	F534~F548	Deceleration time setting for the speeds from Stage 1 to stage 15	0.1~3000S	0.2~3.7KW:5.0S; 5.5~30KW:30.0S; Above 37KW: 60.0S	√
	F549~F556	Running directions of stage speeds from Stage 1 to stage 8	0: forward running; 1: reverse running	0	√
	F557~F564	Running time of stage speeds from Stage 1 to stage 8	0.1~3000S	1.0S	√
	F565~F572	Stop time after finishing stages from Stage 1 to stage 8.	0.0~3000S	0.0S	√
	F573~F579	Running directions of stage speeds from Stage 9 to stage 15.	0: forward running; 1: reverse running	0	√
	F580	Reserved			
Function Section	Function Code	Function Definition	Setting Range	Mfr's Value	Change
Auxiliary Functions	F600	DC Braking Function Selection	0: not allowed; 1: braking before starting; 2: braking during stopping; 3: braking during starting and stopping	0	√
	F601	Initial Frequency for DC Braking	1.00~5.00	1.00	√
	F602	DC Braking Voltage before Starting	0~60	10	√
	F603	DC Braking Voltage During Stop	0~60	10	√
	F604	Braking Lasting Time Before Starting	0.0~10.0	0.5	√
	F605	Braking Lasting Time During Stopping	0.0~10.0	0.5	√
	F606	Reserved			
	F607	Selection of Stalling Adjusting Function	0: invalid; 1: valid	0	√
	F608	Stalling Current Adjusting (%)	60~200	160	√
	F609	Stalling Voltage Adjusting (%)	60~200	140	√
	F610	Stalling Protection Judging Time	0.1~3000.0	5.0	√
	F611	Energy Consumption Brake Point	200~1000	Single phase :380V Three phase: 710V	△
	F612	Discharging percentage	0~100%	80	×
F613~F630	Reserved				

Function Section	Function Code	Function Definition	Setting Range	Mfr's Value	Change
Timing Control and Protection	F700	Selection of terminal free stop mode	0: free stop immediately; 1: delayed free stop	0	√
	F701	Delay time for free stop and programmable terminal action	0.0~60.0s	0.0	√
	F702	Fan control mode	0:controlled by temperature 1: Do not controlled by temperature 2: Controlled by running status	Mfr's value: 2	×
	F703	Setting fan control temperature	0~100℃	35℃	×
	F704	Inverter Overloading pre-alarm Coefficient	50%~100%	80%	*
	F705	Motor Overloading pre-alarm Coefficient	50%~100%	80%	*
	F706	Inverter Overloading Coefficient%	120~190	150	×
	F707	Motor Overloading Coefficient %	20~100	100	×
	F708	Record of The Latest Malfunction Type	Setting range: 2: hardware over current (OC) 3: over voltage (OE) 4: input out-phase (PF1) 5: inverter overload (OL1) 6: under voltage (LU) 7: overheat (OH) 8: motor overload (OL2) 11: external malfunction (ESP) 13. studying parameters without motor (Err2) 16: software over current (OC1) 17: output out-phase (PF0)		△
	F709	Record of Malfunction Type for Last but One			△
F710	Record of Malfunction Type for Last but Two			△	
Timing Control and Protection	F711	Fault Frequency of The Latest Malfunction			△
	F712	Fault Current of The Latest Malfunction			△
	F713	Fault PN End Voltage of The Latest Malfunction			△
	F714	Fault Frequency of Last Malfunction but One			△
	F715	Fault Current of Last Malfunction but One			△
	F716	Fault PN End Voltage of Last Malfunction but One			△
	F717	Fault Frequency of Last Malfunction but Two			△
	F718	Fault Current of Last Malfunction but Two			△
	F719	Fault PN End Voltage of Last Malfunction but Two			△
	F720	Record of overcurrent protection fault times			△

F721	Record of overvoltage protection fault times			△
F722	Record of overheat protection fault times			△
F723	Record of overload protection fault times			△
F724	Input out-phase	0: invalid; 1: valid	1	×
F725	Undervoltage	0: invalid; 1: valid	1	×
F726	Overheat	0: invalid; 1: valid	1	×
F727	Output out-phase	0: invalid; 1: valid	0	○
F728	Input out-phase filtering constant	0.1~60.0	0.5	√
F729	Undervoltage filtering constant	0.1~60.0	5.0	√
F730	Overheat protection filtering constant	0.1~60.0	5.0	√
F737	Software over-current protection	0:Invalid 1: Valid	0	×
F738	Software over-current protection Coefficient	0.50~3.00	2.0	×
F739	Software over-current protection record			△
F740	Reserved			

Function Section	Function Code	Function Definition	Setting Range	Mfr's Value	Change
Motor Parameters	F800	Motor's parameters selection	Setting range: 0: no parameter measurement; 1: Stator resistance parameter measurement;	0	×
	F801	Rated power	0.2~1000KW		×
	F802	Rated voltage	1~440V		×
	F803	Rated current	0.1~6500A		×
	F804	Number of motor poles	2~100	4	×
	F805	Rated rotary speed	1~30000		×
	F806	Stator resistance	0.001~65.00Ω		×
	F807~F809	Reserved			
	F810	Motor rated frequency	1.0~650.0Hz	50.00	×
	F811~F830	Reserved			
Communication Parameter	F900	Communication Address	1~255: single inverter address 0: broadcast address	1	√
	F901	Communication Mode	1: ASCII 2: RTU 3: Remote controlling keypad	1	√
	F902	Reserved			
	F903	Odd/Even Calibration	0: no calibration 1: odd calibration 2: even calibration	0	√
	F904	Baud Rate	0: 1200; 1: 2400; 2: 4800; 3: 9600; 4: 19200 5: 38400 6: 57600	3	√
	F905~F930	Reserved			
PID Parameters	FA00	Polarity	0: positive feedback 1: negative feedback	0	×
	FA01	Reference Source	0: Given Digit 1: AI1 2: AI2 3: Input pulse given; 4~5: Reserved	0	×
	FA02	Given Digit Reference Source	0.0~100.0	50.0	√
	FA03	Feedback Source	0: AI1 1: AI2 2: Input pulse frequency; 3~5: Reserved	0	×
	FA04	Proportion Coefficient	0.0~100.0	20.0	√
	FA05	Integral Time	0.1~10.0S	2.0	√
	FA06	Precision	0.0~20.0	0.1	√
	FA07	Show value of min feedback	0~9999	0	√
	FA08	Show value of max feedback	0~9999	1000	√
	FA09	Reserved			
	FA10	Dormancy function selection	0: Invalid 1: Valid	0	√
FA11	Dormancy waking value	0~100 (%)	10	√	

	FA12	Feedback limit value	0~100 (%)	80	√
	FA13	Dormancy delay time	0~300.0 (S)	60.0S	√
	FA14	Wake delay time	0~300.0 (S)	60.0S	√
	FA15~FA30	Reserved			

Note: × indicating that function code can only be modified in stop state.

√ indicating that function code can be modified both in stop and run state.

Δ indicating that function code can only be checked in stop or run state but cannot be modified.

○ indicating that function code cannot be initialized as inverter restores manufacturer's value but can only be modified manually.

2010070608A